

Reyem

1984-2024

40 YEARS

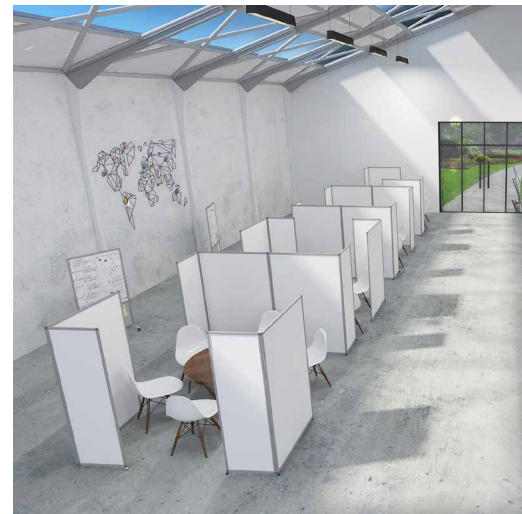
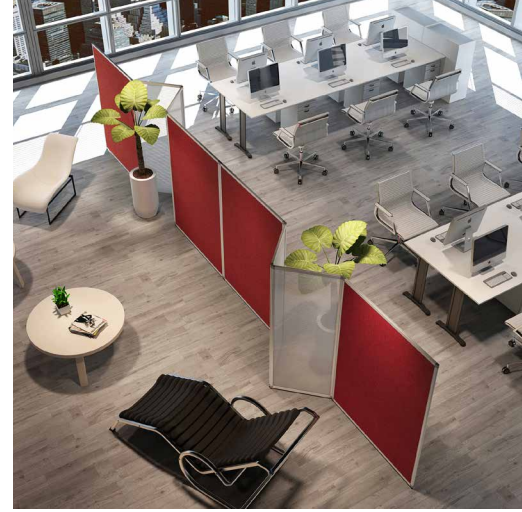

CLOISONNETTES

+SOLUTIONS ACOUSTIQUES



OFFICE SCREENS

+ACOUSTIC SOLUTIONS



STELLWÄNDE

+AKUSTISCHE LÖSUNGEN



Available on

pCon
PLANNER

2024



2024

FABRICATION
FRANCAISE
DEPUIS 40 ANS

40% DE LA
PRODUCTION
EXPORTEE

PLUS DE 500
REVENDEURS
EN EUROPE



2024

MADE IN
FRANCE
FOR 40 YEARS

40% OF THE
PRODUCTION IS
EXPORTED

OVER 500
DEALERS IN
EUROPE



2024

FRANZÖSISCHE
PRODUKTION
SEIT 40 JAHREN

40% DER
ERZEUGNISSE
EXPORTIERT

MEHR ALS 500
HÄNDLER IN
EUROPA



Piétements & roulettes
Feet & castors
Füße & Rollen **30**

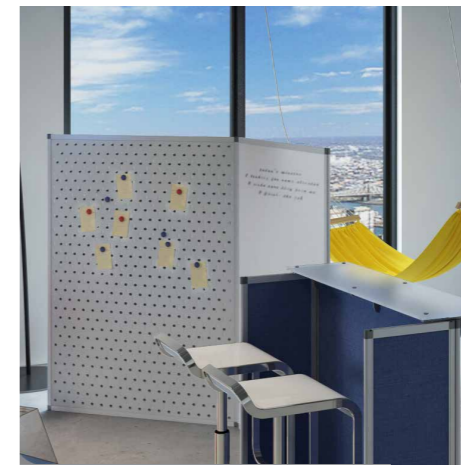

Tôle perforée magnétique
Magnetic perforated metal sheet
Magnetisch Lochblech **32**



Panneaux pour banque d'accueil
Panels for reception desk
Wände für Empfangstheke **33**

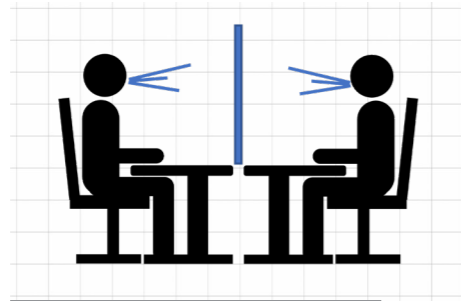

Protections COVID-19
COVID-19 protections
COVID-19 Schutzwände **6 & 25**

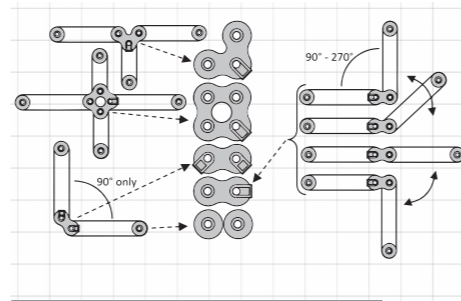

Système d'assemblage
Assembly system
Montagesystem **8**

Available on
pCon
PLANNER



Mélaminé
Melamine
Melamin **10**



Tissu
Fabric
Stoff **14**



Acoustique
Acoustic
Akustik **20**



Postes de travail & Call Center
Workstations & Call center
Arbeitsplätze & Call Center **34**



Réhausse + écran en verre
Glass desk screen + topper
Glaswände + Aufsatz **38**



Accessoires
Accessories
Zubehör **40**



Super-Acoustique
Super-Acoustic
Super-Akustik **22**



Verre acrylique + Polycarbonate
Acrylic glass & Polycarbonate
Acrylglas & Polycarbonat **24**



Panneaux d'affichage magnétiques
Magnetic notice boards
Magnetische Anschlagtafeln **28**

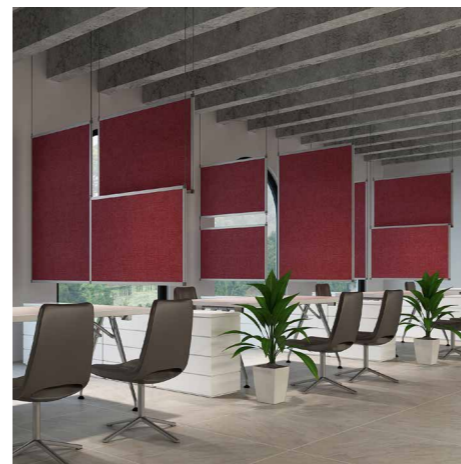

Solutions acoustiques
Acoustic solutions
Akustische Lösungen **42**



Cloisons mobiles sur roulettes
Freestanding screens on castors
Bewegliche Wände auf Rollen **44**



Conditions de transport
Conditions of transport
Beförderungsbedingungen **46**



**PROTECTIONS
COVID-19**



**COVID-19
PROTECTIONS**



**COVID-19
SCHUTZWÄNDE**

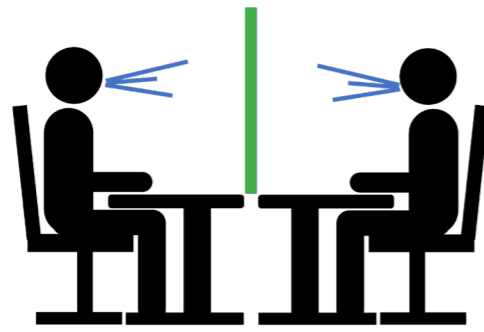

Voir pages 25-27

See pages 25-27

Siehe Seiten 25-27

Verre acrylique incolore 3 ou 4mm
Dimensions standards ou sur mesure

Dimensions maximum conseillées :
Epaisseur 3mm Ref. PX3 : 800 x 800 mm
Epaisseur 4mm Ref. PX4 : 1000x1000mm
Découpe sur mesure, veuillez nous consulter

3 or 4mm colourless acrylic glass
Standard or custom dimensions

Maximum dimensions:
3mm thick Ref. PX3: 800 x 800 mm
4mm thick Ref. PX4: 1000 x 1000mm
Cut to size, please contact us

3 oder 4mm Klaracrylglas
Standard- oder benutzerdefinierte
Abmessungen

Maximale Abmessungen:
3mm dick Ref. PX3: 800 x 800 mm
4mm dick Ref. PX4: 1000 x 1000mm
Zuschnitt nach Maß, kontaktieren Sie uns

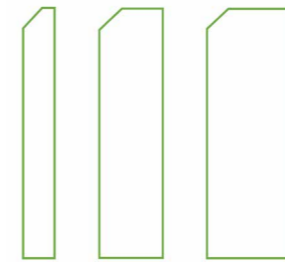

Hauteur
Height
Höhe

390 mm

Ref. PX3 390 x 50
Ref. PX4 390 x 50
Ref. PX3 390 x 100
Ref. PX4 390 x 100
Ref. PX3 390 x 150
Ref. PX4 390 x 150

590 mm

Ref. PX3 590 x 50
Ref. PX4 590 x 50
Ref. PX3 590 x 100
Ref. PX4 590 x 100
Ref. PX3 590 x 150
Ref. PX4 590 x 150

Hauteur
Height
Höhe

590 mm

Ref. PX3 590 x 190
Ref. PX4 590 x 190
Ref. PX3 590 x 390
Ref. PX4 590 x 390
Ref. PX3 590 x 590
Ref. PX4 590 x 590
Ref. PX3 590 x 790
Ref. PX4 590 x 790

790 mm

Ref. PX3 790 x 190
Ref. PX4 790 x 190
Ref. PX3 790 x 390
Ref. PX4 790 x 390
Ref. PX3 790 x 590
Ref. PX4 790 x 590
Ref. PX3 790 x 790
Ref. PX4 790 x 790

Connecteur
pour verre acrylique de 3 ou 4mm

Connector
for 3 or 4mm acrylic glass

Verbinder
für 3 oder 4mm Acrylglas



Ref. PLE 204



Ref. PLE 202



Ref. PLE 203



Ref. PLE 222

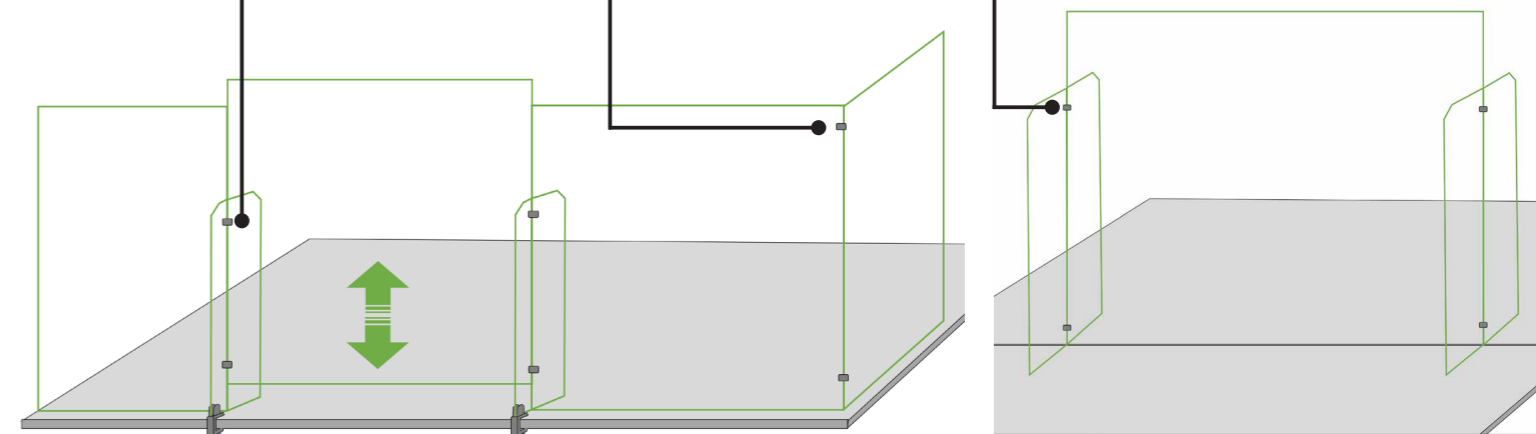

Ref. MVM 280 → 10 - 28mm



Ref. MVM 380 → 20 - 38mm



Ref. MVM 280

Ref. MVM 380

Pince bureau métallique
+ clip pour verre acrylique de 3 ou 4 mm

Metal desk clamp
+ clip for 3 or 4mm acrylic glass

Tischklammer
+ Klip für 3 oder 4mm Acrylglas

SYSTÈME D'ASSEMBLAGE

ASSEMBLY SYSTEM

MONTAGE-SYSTEM

FICHE TECHNIQUE

TECHNICAL DATA

TECHNISCHEN DATEN

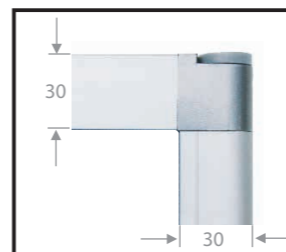
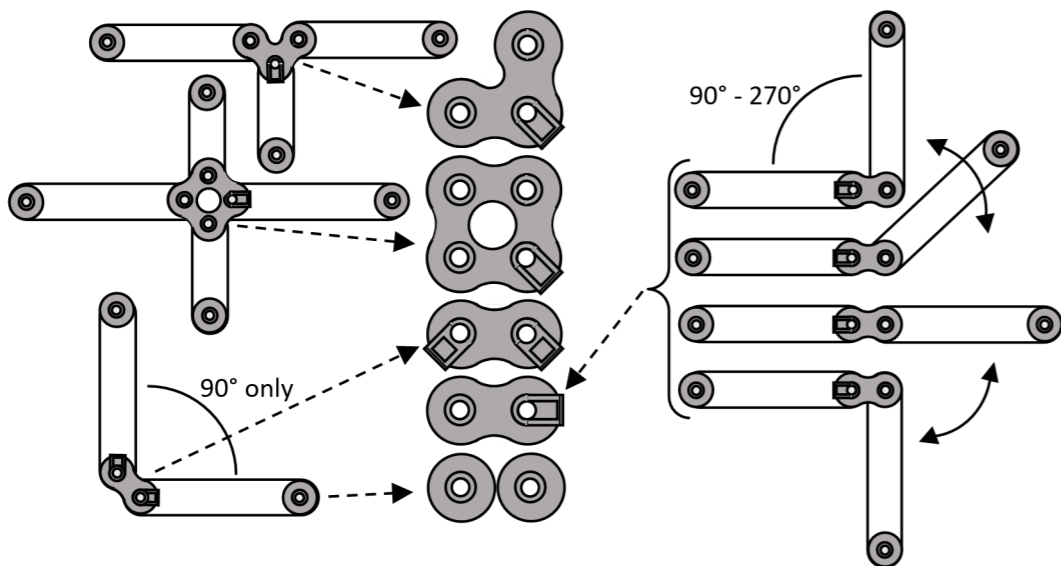
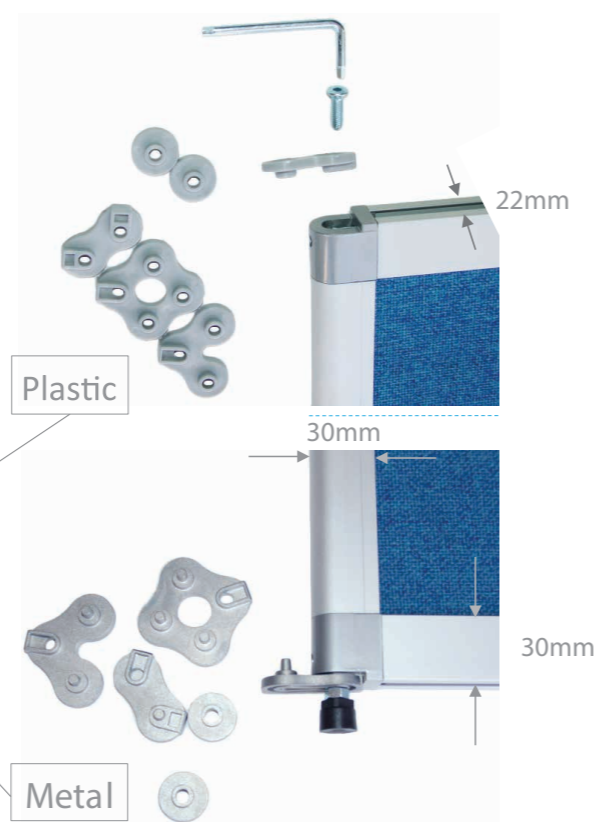
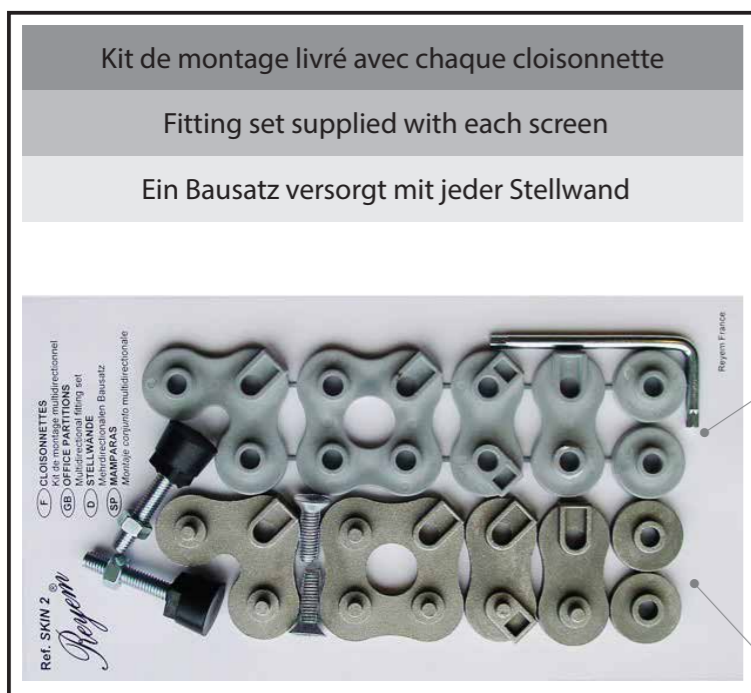
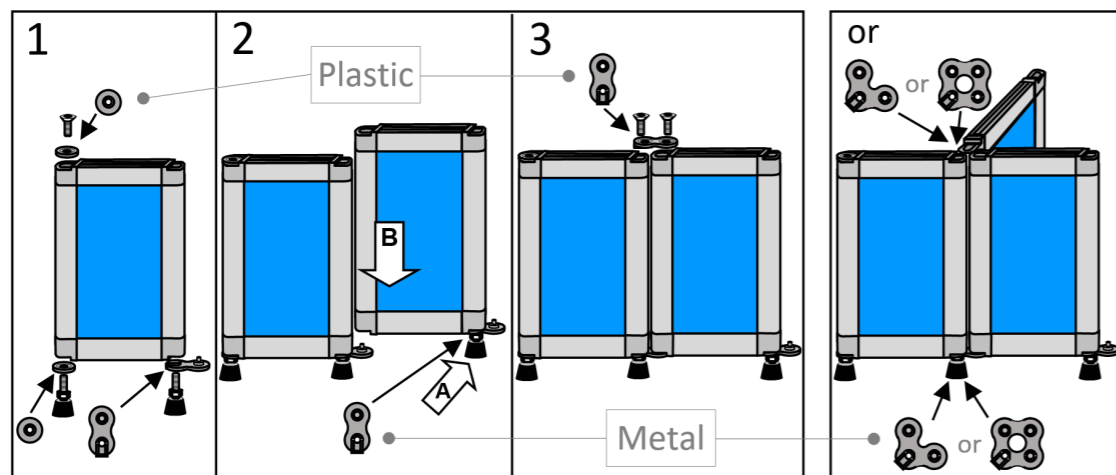

OSSATURE
Toutes les cloisons Reyem sont fabriquées avec une ossature en aluminium anodisé nature de 30mm, d'épaisseur 22mm et assemblées avec des pièces d'angle en alliage de zinc, peinture liquide RAL 9006.

FRAME
Each Reyem screen is made using a colourless, anodised aluminium frame of 30mm and 22mm thick. The frame is assembled with corner pieces made of a zinc alloy, liquid paint RAL 9006.

RAHMEN
Jede Reyem-Wand wird mit einem 30mm und 22mm dicken Rahmen aus farblosem, eloxiertem Aluminium gefertigt. Der Rahmen wird mit zinklegierten Eckstücken, flüssige Farbe RAL 9006 zusammengesetzt.

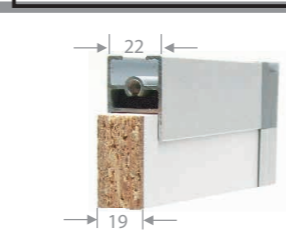

MELAMINE
Mélaminé d'épaisseur 19mm, classement au feu M3 / D, s2, d0. Classement au feu M1 / B, s2, d0 possible, veuillez nous consulter pour prix et délais. Coloris page 11

MELAMINE
19mm thick melamine, fire safety classification: D, s2, d0. Fire safety classification B, s2, d0 possible, please contact us for price and delivery time. Colours page 11

MELAMIN
19mm Melamin, Feuersicherung: D, s2, d0. Feuersicherung B, s2, d0 möglich, bitte kontaktieren Sie uns für Preis und Lieferzeit. Melaminfarben Seite 11

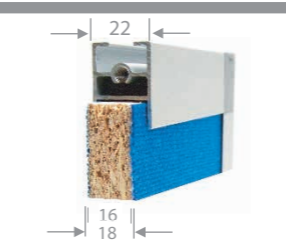

TISSU
Aggloméré de 16mm 100% PEFC et FSC + Colle à l'eau + Textile (voir page 15) Tests acoustiques page 17

FABRIC
16mm thick chipboard 100% PEFC et FSC + Water glue + Textile (see page 15) Acoustic tests page 17

STOFF
16mm Spanplatten 100% PEFC- und FSC-zertifiziert + Wasser-Leim + Textil (siehe Seite 15) Akustikteste Seite 17

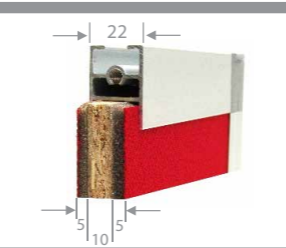

ACOUSTIQUE
Aggloméré de 10mm 100% PEFC et FSC + 2 x 5mm de mousse 100% polyuréthane, densité 23 kg/m3 + Colle à l'eau + Textile (voir page 15) Tests acoustiques page 17

ACOUSTIC
10mm thick chipboard 100% PEFC et FSC + 2 x 5mm foam 100% polyurethane, density 23 kg/m3 + Water glue + Textile (see page 15) Acoustic tests page 17

AKUSTIK
10mm Spanplatten 100% PEFC- und FSC-zertifiziert + 2 x 5mm Schaum 100% Polyurethan, Dichte 23 kg/m3 + Wasser-Leim + Textil (siehe Seite 15) Akustikteste Seite 17

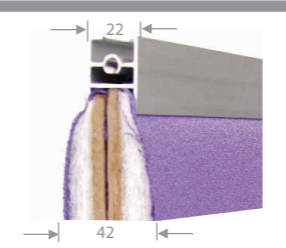

SUPER-ACOUSTIQUE
2 x 5mm de Medium Density Fibreboard (MDF) + 2 x 15mm de fibre 100% polyester, densité 30 kg/m3 + Textile (voir page 15) Tests acoustiques page 17

SUPER-ACOUSTIC
2 x 5mm thick Medium Density Fibreboard (MDF) + 2 x 15mm 100% polyester fibre, density 30 kg/m3 + Textile (see page 15) Acoustic tests page 17

SUPER-AKUSTIK
2 x 5mm Medium Density Fibreboard (MDF) + 2 x 15mm 100% Polyesterfaser, Dichte 30 kg/m3 + Textil (siehe Seite 15) Akustikteste Seite 17



VERRE ACRYLIQUE
Finition verre acrylique 3mm. Incolore, fumé gris, ou opale, résistance durable aux UV, classement feu M4 / E. + Profilé de compensation en PVC noir

ACRYLIC GLASS
3mm thick acrylic glass. Colourless, gray tinted or opal, long-lasting UV resistance, fire safety classification: E. + compensator profile made of black PVC

ACRYLGLAS
3mm Acrylglas, Klar, grau Rauch oder Opal. Langlebig UV-beständig, Feuersicherung: E. + Kompensator Profil schwarz PVC



POLYCARBONATE ALVÉOLAIRE
Finition polycarbonate alvéolaire incolore 6mm. Protection UV par coextrusion, classement au feu M1 / B, s1, d0 + Profilé de compensation en PVC

ALVEOLAR POLYCARBONATE
6mm thick colourless alveolar polycarbonate. UV protection by coextrusion, fire classification: B, s1, d0 + compensator profile made of black PVC

POLYCARBONAT
6mm Klarpolycarbonat, UV-beständigkeit (Coextrusion), Feuersicherung Class B, s1, d0. + Kompensator Profil schwarz PVC

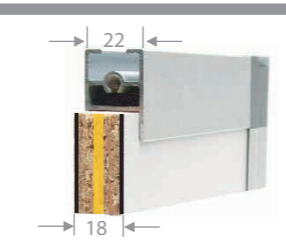

AFFICHAGE MAGNÉTIQUE
Face magnétique émaillée blanche (disponible en 1 ou 2 faces)

MAGNETIC NOTICE BOARDS
Enameled white magnetic side (available on 1 or 2 sides)

MAGNETISCHE ANSCHLAGTAFELN
Emailliert weiß magnetisch Seite (Verfügbar auf 1 oder 2 Seiten)



MÉLAMINÉ



MELAMINE



MELAMIN



Méla miné d'épaisseur 19mm, fibre du bois horizontal (Epaiss eur 8mm possible, voir page 45). 100% PEFC et FSC.

19mm thick melamine, wood fiber horizontal (8mm thick melamine possible, see page 45). 100% PEFC and FSC.

19mm Melamin, Waagrecht Holz faser (8mm Melamin möglich, siehe Seite 45). 100% PEFC- und FSC-zertifiziert.



Noyer
Walnut wood
Nussbaum



H 3734



U 963



U 113

Hêtre
Beech
Buche



H 1582



U 732

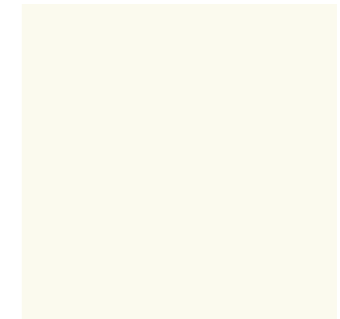

W 908

Erable
Maple
Ahorn



375 M



U 708



U 500

Pour un classement au feu M1 / B, s2, d0, d'autres méla minés ou coloris, veuillez nous consulter.

Les photographies des méla minés sont présentées à titre indicatif. Des variations de couleurs peuvent se produire. Nous vous conseillons de demander de vrais échantillons.

For B, s2, d0 fire safety classification, other melamine or colour finishes, please contact us.

The photographs of the melamine finishes are shown as a guideline only. Colours may vary. We recommend that you ask for samples before ordering.

Bei Fragen bezüglich der Brandschutzklasseneinstufung B, s2, d0, anderen Melaminbeschichtungen oder Farbtönen wenden Sie sich an uns.

Die Abbildungen der Melaminbeschichtungen sind unverbindlich. Es können Farbabweichungen auftreten. Wir empfehlen Ihnen, echte Probemuster anzufordern.

 **CLOISONNETTE MÉLAMINÉ**

 **MELAMINE SCREEN**

 **MELAMIN-STELLWAND**

 Kit de montage livré avec chaque cloisonnette
 Fitting set supplied with each screen
 Ein Bausatz versorgt mit jeder Stellwand

Hauteur Height Höhe	1200 mm	1400 mm	1600 mm	1800 mm
	Ref. MMM 1200 x 610 Ref. MMM 1200 x 810 Ref. MMM 1200 x 1010 Ref. MMM 1200 x 1210 Ref. MMM 1200 x 1410 Ref. MMM 1200 x 1610	Ref. MMM 1400 x 610 Ref. MMM 1400 x 810 Ref. MMM 1400 x 1010 Ref. MMM 1400 x 1210 Ref. MMM 1400 x 1410 Ref. MMM 1400 x 1610	Ref. MMM 1600 x 610 Ref. MMM 1600 x 810 Ref. MMM 1600 x 1010 Ref. MMM 1600 x 1210 Ref. MMM 1600 x 1410 Ref. MMM 1600 x 1610	Ref. MMM 1800 x 610 Ref. MMM 1800 x 810 Ref. MMM 1800 x 1010 Ref. MMM 1800 x 1210 Ref. MMM 1800 x 1410 Ref. MMM 1800 x 1610

Avec verre acrylique 3mm ou polycarbonate alvéolaire 6mm
 With 3mm acrylic glass or 6mm alveolar polycarbonate
 Mit 3mm Acrylglas oder 6mm Klarpolycarbonat

Ref. _____	1200 x 610	1400 x 610	1600 x 610	1800 x 610
Ref. _____	1200 x 810	1400 x 810	1600 x 810	1800 x 810
Ref. _____	1200 x 1010	1400 x 1010	1600 x 1010	1800 x 1010
Ref. _____	1200 x 1210	1400 x 1210	1600 x 1210	1800 x 1210
Ref. _____	1200 x 1410	1400 x 1410	1600 x 1410	1800 x 1410
Ref. _____	1200 x 1610	1400 x 1610	1600 x 1610	1800 x 1610



Incolore	Fumé gris	Opale	Polycarbonate alvéolaire incolore Classement feu M1 / B, s1, d0
Colourless	Gray tinted	Opal	Clear alveolar polycarbonate Fire safety classification B, s1, d0
Klar	Grau Rauch	Opal	Klarpolycarbonat Feuersicherung Class B, s1, d0



Ref. MVP 300
Pied sur platine plate
 Prix unitaire
Foot on flat plate
 Unit price
Fuß auf flacher Platte
 Stückpreis

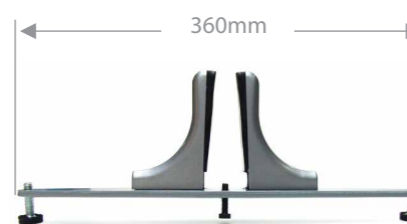

Ref. MVP 360
Pied Réglable
 Prix unitaire
Adjustable foot
 Unit price
Verstellbarer Fuß
 Stückpreis

 **ÉCRAN DE BUREAU MÉLAMINÉ**

 **MELAMINE DESK SCREEN**

 **MELAMIN-TISCH-TRENNWAND**

Hauteur Height Höhe	400 mm	600 mm	800 mm
	Ref. MMB 400 x 800 Ref. MMB 400 x 1000 Ref. MMB 400 x 1200 Ref. MMB 400 x 1400 Ref. MMB 400 x 1600 Ref. MMB 400 x 1800	Ref. MMB 600 x 800 Ref. MMB 600 x 1000 Ref. MMB 600 x 1200 Ref. MMB 600 x 1400 Ref. MMB 600 x 1600 Ref. MMB 600 x 1800	Ref. MMB 800 x 800 Ref. MMB 800 x 1000 Ref. MMB 800 x 1200 Ref. MMB 800 x 1400 Ref. MMB 800 x 1600 Ref. MMB 800 x 1800



Avec verre acrylique incolore, fumé gris ou opale de 3mm ou polycarbonate alvéolaire de 6mm, à préciser à la commande
 With 3mm colourless, gray tinted or opal acrylic glass or 6mm alveolar polycarbonate, please specify when ordering
 Mit 3mm Klar, grau Rauch oder Opal Acrylglas oder 6mm Klarpolycarbonat, bitte bei Bestellung angeben

Ref. MMA 600 x 800 Ref. MMA 600 x 1000 Ref. MMA 600 x 1200 Ref. MMA 600 x 1400 Ref. MMA 600 x 1600 Ref. MMA 600 x 1800	Ref. MMA 800 x 800 Ref. MMA 800 x 1000 Ref. MMA 800 x 1200 Ref. MMA 800 x 1400 Ref. MMA 800 x 1600 Ref. MMA 800 x 1800
---	---

Prix unitaire Unit price Stückpreis



Position et quantité de pinces nécessaires selon l'implantation
 Clamps position and number required depending on the layout
 Klammern Positionen und Mengen erforderlich je nach Standort.

FIXATION POUR BUREAUX BENCH
 Veuillez préciser l'épaisseur du plateau

FIXING FOR BENCH DESKS
 Please specify the thickness of the desk surface

BEFESTIGUNG FÜR BENCH SCHREIBTISCHE
 Bitte geben Sie die Stärke der Tischplatte an

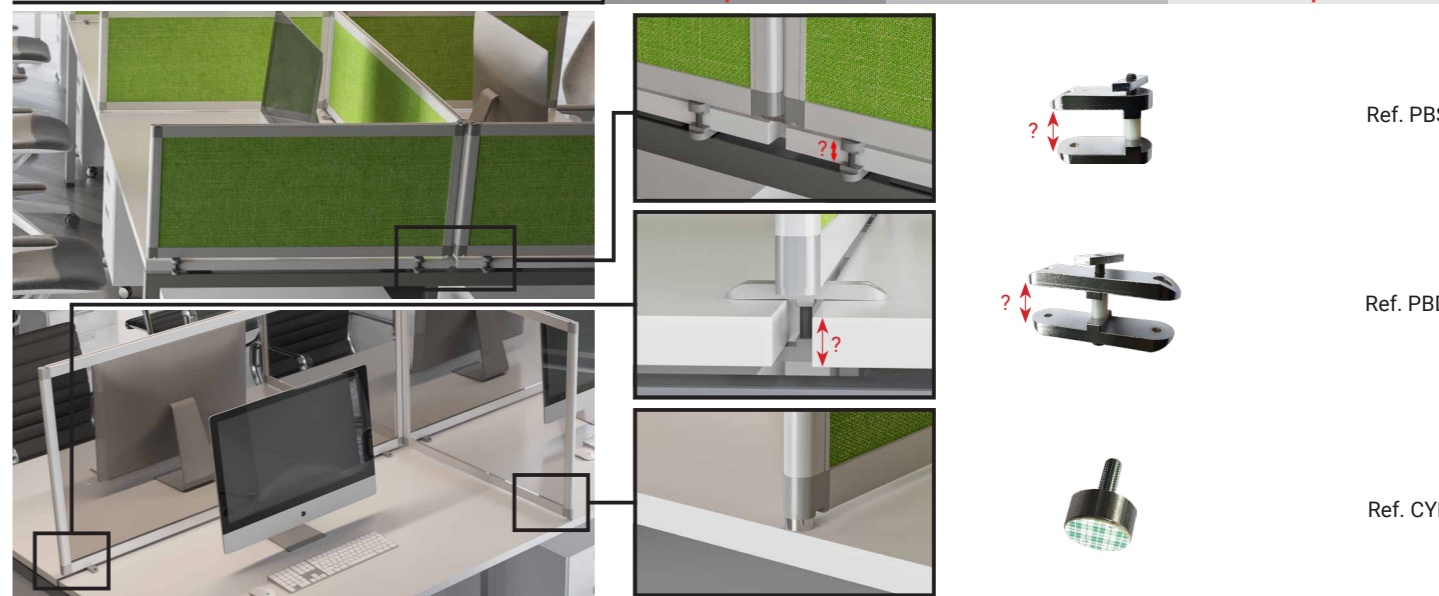

Sabot à poser sur le bureau Base to place on the desk Sockel auf den Tisch zu lege





TISSU



FABRIC



STOFF



40% laine et 60% viscose

40% wool and 60% viscose

40% Wolle und 60% Viskose

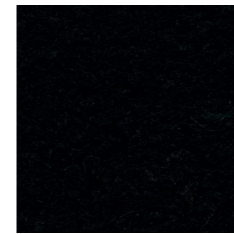

A 204



A 243



A 220

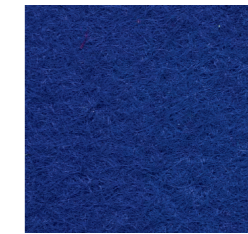

A 228

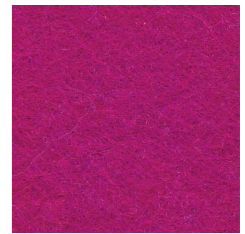

A 221

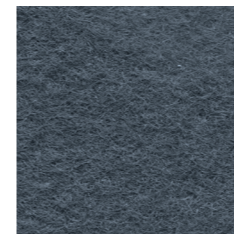

A 203



A 244



A 232

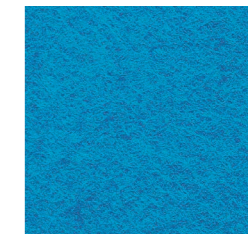

A 229



A 201

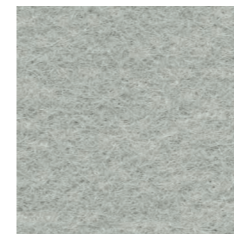

A 230

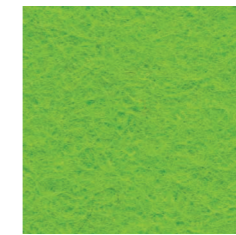

A 235

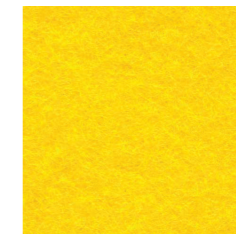

A 206

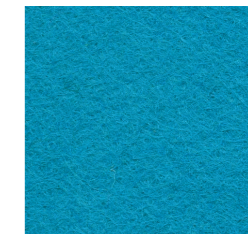

A 231

Moucheté

Speckled

Gesprenkelter

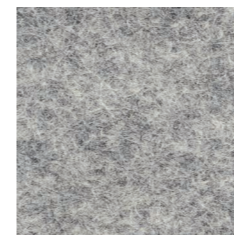

G 365



G 366



G 369

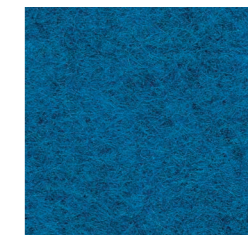

G 370



G 368

Pour d'autres gammes ou coloris, veuillez nous consulter.

Les photographies des tissus sont présentées à titre indicatif. Des variations de couleurs peuvent se produire. Nous vous conseillons de demander de vrais échantillons.

For other fabric range or colours, please contact us.

The photographs of the fabric finishes are shown as a guideline only. Colours may vary. We recommend that you ask for samples before ordering.

Andere Stoffe oder Farbe, kontaktieren Sie uns.

Die Abbildungen der Stoffbeschichtungen sind unverbindlich. Es können Farbabweichungen auftreten. Wir empfehlen Ihnen, echte Probemuster anzufordern.

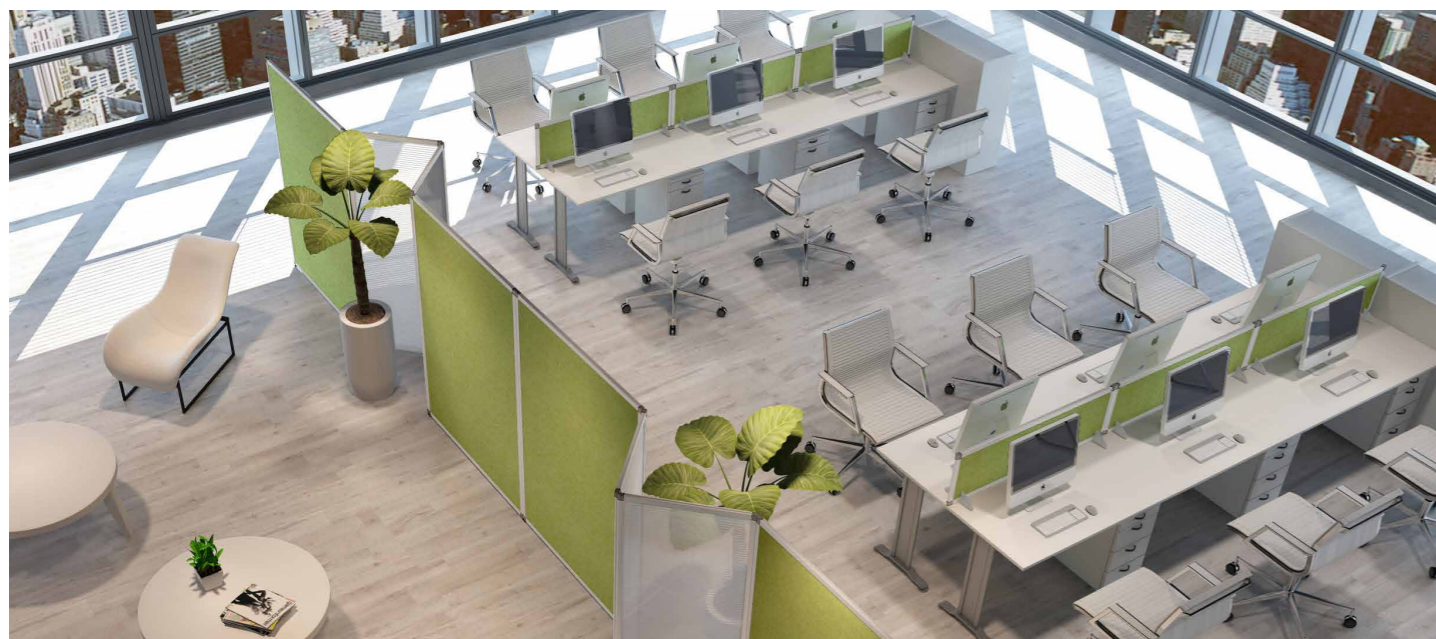

**TESTS
ACOUSTIQUES**

**ACOUSTIC
TESTS**

AKUSTIKTESTE

TISSU

FABRIC

STOFF



ACOUSTIQUE

ACOUSTIC

AKUSTIK



SUPER-ACOUSTIQUE

SUPER-ACOUSTIC

SUPER-AKUSTIK

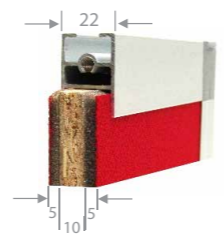
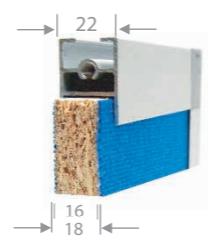

- 2 x 5mm de mousse + tissu
- 2 x 5mm foam + fabric
- 2 x 5mm Schaum + Stoff



Le coefficient α_s exprime l'absorption de l'énergie sonore par la cloison de 0 à 1 (0 à 100%). Dans les bureaux, les fréquences se situent généralement entre 500 et 4000 Hertz (sons graves ou aigus). Le coefficient α_w exprime l'absorption acoustique pondérée.

The α_s coefficient is used to describe the partition's sound absorption on a scale from 0 to 1 (0 to 100%). In offices, these levels generally remain between 500 and 4000 Hertz (low- or high-pitched sounds). The α_w coefficient describes the weighted acoustic absorption.

Der Koeffizient α_s gibt die von der Trennwand absorbierte Schallenergie von 0 bis 1 (0 bis 100%) an. In Büros liegen die Frequenzen in der Regel zwischen 500 und 4000 Hertz (tiefe oder hohe Töne). Der Koeffizient α_w gibt den gewichteten Schallabsorptionsgrad an.

α_w	Mélangé	Tissu	Acoustique	Super-Acoustique
	Melamine	Fabric	Acoustic	Super-Acoustic
	Melamin	Stoff	Akustik	Super-Akustik
	0,05(I)	0,1(I)	0,15(H)	0,45(H)
Frequency (Hz)	α_s			
100	0,00	0,00	0,00	0,13
125	0,00	0,01	0,00	0,19
160	0,02	0,00	0,04	0,22
200	0,00	0,00	0,04	0,26
250	0,03	0,05	0,07	0,30
315	0,02	0,04	0,05	0,28
400	0,02	0,03	0,04	0,32
500	0,01	0,02	0,05	0,36
630	0,03	0,04	0,08	0,41
800	0,02	0,04	0,12	0,45
1000	0,03	0,05	0,14	0,52
1250	0,04	0,08	0,16	0,60
1600	0,03	0,09	0,21	0,70
2000	0,04	0,08	0,24	0,79
2500	0,05	0,10	0,31	0,87
3150	0,04	0,09	0,38	0,91
4000	0,08	0,11	0,44	0,94
5000	0,20	0,21	0,53	0,96

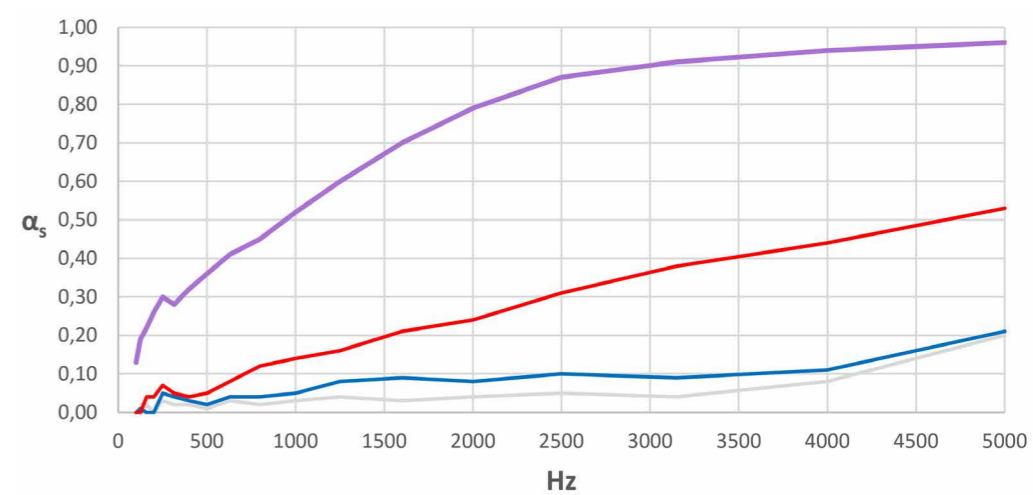
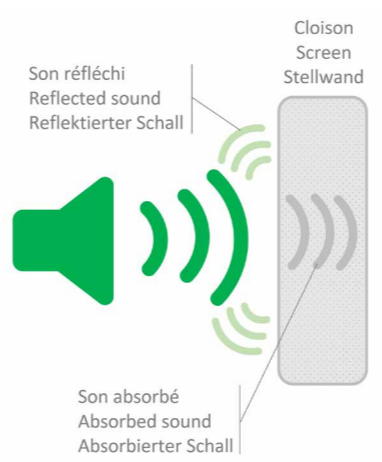

Solutions Acoustiques page 42

Acoustic Solutions page 42

Akustische Lösungen Seite 42

 **CLOISONNETTE
TISSU**

 **FABRIC
SCREEN**

 **STOFF-
STELLWAND**



Kit de montage livré avec chaque cloisonnette

Fitting set supplied with each screen

Ein Bausatz versorgt mit jeder Stellwand

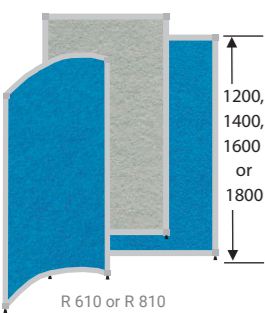

Hauteur Height Höhe	1200 mm	1400 mm	1600 mm	1800 mm
	Ref. MTT 1200 x 610 Ref. MTT 1200 x 810 Ref. MTT 1200 x 1010 Ref. MTT 1200 x 1210 Ref. MTT 1200 x 1410 Ref. MTT 1200 x 1610	Ref. MTT 1400 x 610 Ref. MTT 1400 x 810 Ref. MTT 1400 x 1010 Ref. MTT 1400 x 1210 Ref. MTT 1400 x 1410 Ref. MTT 1400 x 1610	Ref. MTT 1600 x 610 Ref. MTT 1600 x 810 Ref. MTT 1600 x 1010 Ref. MTT 1600 x 1210 Ref. MTT 1600 x 1410 Ref. MTT 1600 x 1610	Ref. MTT 1800 x 610 Ref. MTT 1800 x 810 Ref. MTT 1800 x 1010 Ref. MTT 1800 x 1210 Ref. MTT 1800 x 1410 Ref. MTT 1800 x 1610
	Ref. MTT 1200 x R610 Ref. MTT 1200 x R810	Ref. MTT 1400 x R610 Ref. MTT 1400 x R810	Ref. MTT 1600 x R610 Ref. MTT 1600 x R810	Ref. MTT 1800 x R610 Ref. MTT 1800 x R810

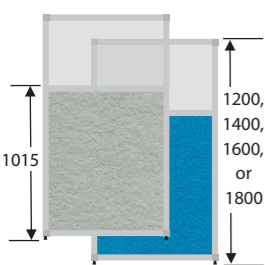

Avec verre acrylique 3mm ou polycarbonate alvéolaire 6mm
With 3mm acrylic glass or 6mm alveolar polycarbonate
Mit 3mm Acrylglas oder 6mm Klarpolycarbonat



Ref. ____ 1200 x 610 Ref. ____ 1200 x 810 Ref. ____ 1200 x 1010 Ref. ____ 1200 x 1210 Ref. ____ 1200 x 1410 Ref. ____ 1200 x 1610	Ref. ____ 1400 x 610 Ref. ____ 1400 x 810 Ref. ____ 1400 x 1010 Ref. ____ 1400 x 1210 Ref. ____ 1400 x 1410 Ref. ____ 1400 x 1610	Ref. ____ 1600 x 610 Ref. ____ 1600 x 810 Ref. ____ 1600 x 1010 Ref. ____ 1600 x 1210 Ref. ____ 1600 x 1410 Ref. ____ 1600 x 1610	Ref. ____ 1800 x 610 Ref. ____ 1800 x 810 Ref. ____ 1800 x 1010 Ref. ____ 1800 x 1210 Ref. ____ 1800 x 1410 Ref. ____ 1800 x 1610
--	--	--	--

Ref. MTJ

Incolore
Colourless
Klar

Ref. MTG

Fumé gris
Gray tinted
Grau Rauch

Ref. MTL

Opale
Opal
Opal

Ref. MTP

Polycarbonate alvéolaire incolore Classement feu M1 / B, s1, d0
Clear alveolar polycarbonate Fire safety classification B, s1, d0
Klarpolycarbonat Feuersicherung Class B, s1, d0

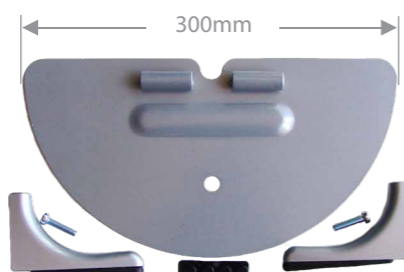

Ref. MVP 300
Pied sur platine plate
Prix unitaire
Foot on flat plate
Unit price
Fuß auf flacher Platte
Stückpreis

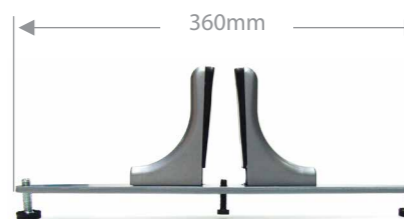

Ref. MVP 360
Pied Réglable
Prix unitaire
Adjustable foot
Unit price
Verstellbarer Fuß
Stückpreis

 **ÉCRAN DE BUREAU
TISSU**

 **FABRIC
DESK SCREEN**

 **STOFF-
TISCH-TRENNWAND**

Hauteur Height Höhe	400 mm	600 mm	800 mm
	Ref. MTB 400 x 800 Ref. MTB 400 x 1000 Ref. MTB 400 x 1200 Ref. MTB 400 x 1400 Ref. MTB 400 x 1600 Ref. MTB 400 x 1800	Ref. MTB 600 x 800 Ref. MTB 600 x 1000 Ref. MTB 600 x 1200 Ref. MTB 600 x 1400 Ref. MTB 600 x 1600 Ref. MTB 600 x 1800	Ref. MTB 800 x 800 Ref. MTB 800 x 1000 Ref. MTB 800 x 1200 Ref. MTB 800 x 1400 Ref. MTB 800 x 1600 Ref. MTB 800 x 1800

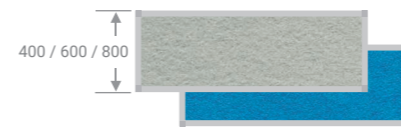

Avec verre acrylique incolore, fumé gris ou opale de 3mm ou polycarbonate alvéolaire de 6mm, à préciser à la commande

With 3mm colourless, gray tinted or opal acrylic glass or 6mm alveolar polycarbonate, please specify when ordering

Mit 3mm Klar, grau Rauch oder Opal Acrylglas oder 6mm Klarpolycarbonat, bitte bei Bestellung angeben



Ref. MTA 600 x 800 Ref. MTA 600 x 1000 Ref. MTA 600 x 1200 Ref. MTA 600 x 1400 Ref. MTA 600 x 1600 Ref. MTA 600 x 1800	Ref. MTA 800 x 800 Ref. MTA 800 x 1000 Ref. MTA 800 x 1200 Ref. MTA 800 x 1400 Ref. MTA 800 x 1600 Ref. MTA 800 x 1800
---	---

Prix unitaire Unit price Stückpreis

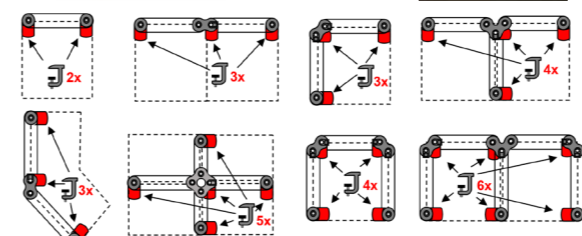

Position et quantité de pinces nécessaires selon l'implantation
Clamps position and number required depending on the layout
Klammern Positionen und Mengen erforderlich je nach Standort.



FIXATION POUR BUREAUX BENCH
Veillez préciser l'épaisseur du plateau
FOR BENCH DESKS
Please specify the thickness of the desk surface
BEFESTIGUNG FÜR BENCH SCHREIBTISCHE
Bitte geben Sie die Stärke der Tischplatte an

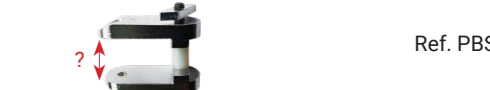
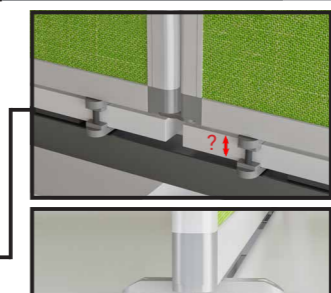

Ref. PBS



Ref. PBD

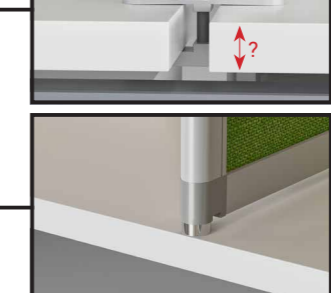

Ref. CYL

Sabot à poser sur le bureau Base to place on the desk Sockel auf den Tisch zu lege



Ref. MVZ 200

**CLOISONNETTE
ACOUSTIQUE**

**ACOUSTIC
SCREEN**

**AKUSTIK-
STELLWAND**



Kit de montage livré avec chaque cloisonnette

Fitting set supplied with each screen

Ein Bausatz versorgt mit jeder Stellwand

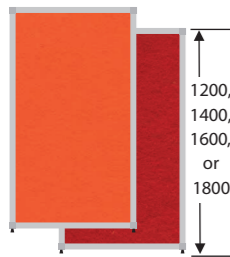

Hauteur Height Höhe	1200 mm	1400 mm	1600 mm	1800 mm
1200, 1400, 1600, or 1800	Ref. FTT 1200 x 610 Ref. FTT 1200 x 810 Ref. FTT 1200 x 1010 Ref. FTT 1200 x 1210 Ref. FTT 1200 x 1410 Ref. FTT 1200 x 1610	Ref. FTT 1400 x 610 Ref. FTT 1400 x 810 Ref. FTT 1400 x 1010 Ref. FTT 1400 x 1210 Ref. FTT 1400 x 1410 Ref. FTT 1400 x 1610	Ref. FTT 1600 x 610 Ref. FTT 1600 x 810 Ref. FTT 1600 x 1010 Ref. FTT 1600 x 1210 Ref. FTT 1600 x 1410 Ref. FTT 1600 x 1610	Ref. FTT 1800 x 610 Ref. FTT 1800 x 810 Ref. FTT 1800 x 1010 Ref. FTT 1800 x 1210 Ref. FTT 1800 x 1410 Ref. FTT 1800 x 1610

Avec verre acrylique 3mm ou polycarbonate alvéolaire 6mm
With 3mm acrylic glass or 6mm alveolar polycarbonate
Mit 3mm Acrylglas oder 6mm Klarpolycarbonat

Ref. ____ 1200 x 610 Ref. ____ 1200 x 810 Ref. ____ 1200 x 1010 Ref. ____ 1200 x 1210 Ref. ____ 1200 x 1410 Ref. ____ 1200 x 1610	Ref. ____ 1400 x 610 Ref. ____ 1400 x 810 Ref. ____ 1400 x 1010 Ref. ____ 1400 x 1210 Ref. ____ 1400 x 1410 Ref. ____ 1400 x 1610	Ref. ____ 1600 x 610 Ref. ____ 1600 x 810 Ref. ____ 1600 x 1010 Ref. ____ 1600 x 1210 Ref. ____ 1600 x 1410 Ref. ____ 1600 x 1610	Ref. ____ 1800 x 610 Ref. ____ 1800 x 810 Ref. ____ 1800 x 1010 Ref. ____ 1800 x 1210 Ref. ____ 1800 x 1410 Ref. ____ 1800 x 1610
--	--	--	--



Ref. FTJ

Incolore
Colourless
Klar



Ref. FTG

Fumé gris
Gray tinted
Grau Rauch



Ref. FTL

Opale
Opal
Opal



Ref. FTP

Polycarbonate alvéolaire incolore
Classement feu M1 / B, s1, d0
Clear alveolar polycarbonate
Fire safety classification B, s1, d0
Klarpolycarbonat
Feuersicherung Class B, s1, d0



Ref. MVP 300

Pied sur platine plate
Prix unitaire
Foot on flat plate
Unit price
Fuß auf flacher Platte
Stückpreis

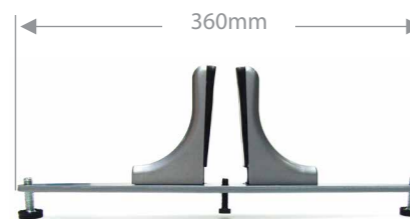

Ref. MVP 360

Pied Réglable
Prix unitaire
Adjustable foot
Unit price
Verstellbarer Fuß
Stückpreis

**ÉCRAN DE BUREAU
ACOUSTIQUE**

**ACOUSTIC
DESK SCREEN**

**AKUSTIK-
TISCH-TRENNWAND**

Hauteur Height Höhe	400 mm	600 mm	800 mm
400 / 600 / 800	Ref. FPB 400 x 800 Ref. FPB 400 x 1000 Ref. FPB 400 x 1200 Ref. FPB 400 x 1400 Ref. FPB 400 x 1600 Ref. FPB 400 x 1800	Ref. FPB 600 x 800 Ref. FPB 600 x 1000 Ref. FPB 600 x 1200 Ref. FPB 600 x 1400 Ref. FPB 600 x 1600 Ref. FPB 600 x 1800	Ref. FPB 800 x 800 Ref. FPB 800 x 1000 Ref. FPB 800 x 1200 Ref. FPB 800 x 1400 Ref. FPB 800 x 1600 Ref. FPB 800 x 1800



Avec verre acrylique incolore, fumé gris ou opale de 3mm ou polycarbonate alvéolaire de 6mm, à préciser à la commande

With 3mm colourless, gray tinted or opal acrylic glass or 6mm alveolar polycarbonate, please specify when ordering

Mit 3mm Klar, grau Rauch oder Opal Acrylglas oder 6mm Klarpolycarbonat, bitte bei Bestellung angeben

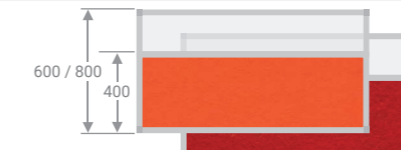

Ref. FPA 600 x 800 Ref. FPA 600 x 1000 Ref. FPA 600 x 1200 Ref. FPA 600 x 1400 Ref. FPA 600 x 1600 Ref. FPA 600 x 1800	Ref. FPA 800 x 800 Ref. FPA 800 x 1000 Ref. FPA 800 x 1200 Ref. FPA 800 x 1400 Ref. FPA 800 x 1600 Ref. FPA 800 x 1800
---	---

Prix unitaire	Unit price	Stückpreis
---------------	------------	------------



Ref. MVT 280
Ref. MVT 380

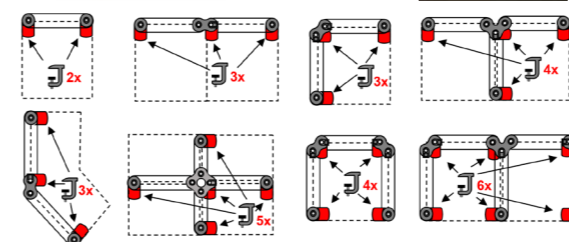

Position et quantité de pinces nécessaires selon l'implantation
Clamps position and number required depending on the layout
Klammern Positionen und Mengen erforderlich je nach Standort.



Ref. MVU 280
Ref. MVU 380

FIXATION POUR BUREAUX BENCH
Veillez préciser l'épaisseur du plateau
FIXING FOR BENCH DESKS
Please specify the thickness of the desk surface
BEFESTIGUNG FÜR BENCH SCHREIBTISCHE
Bitte geben Sie die Stärke der Tischplatte an



Sabot à poser sur le bureau

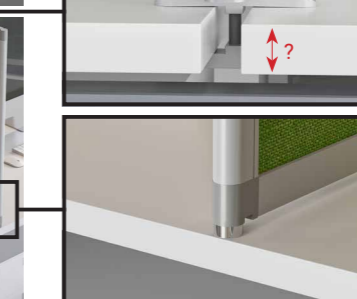
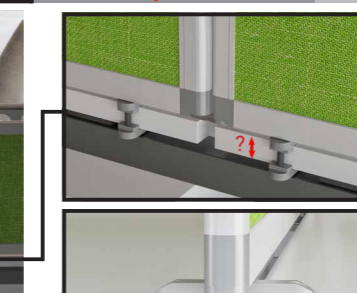

Base to place on the desk

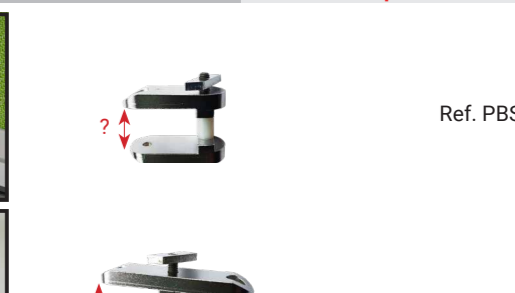

Ref. PBS



Ref. PBD

Sockel auf den Tisch zu lege

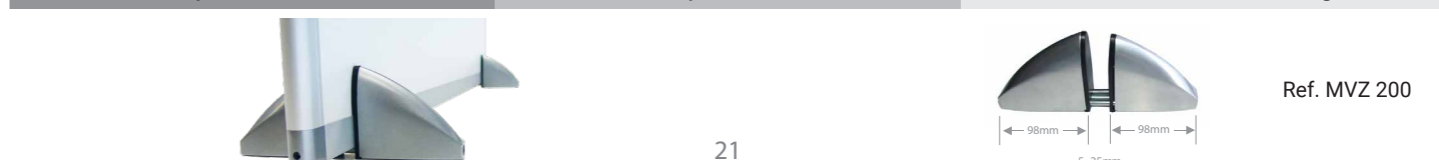

Ref. MVZ 200

**CLOISONNETTE
SUPER-ACOUSTIQUE**

**SUPER-ACOUSTIC
SCREEN**

**SUPER AKUSTIK-
STELLWAND**



Kit de montage livré avec chaque cloisonnette

Fitting set supplied with each screen

Ein Bausatz versorgt mit jeder Stellwand

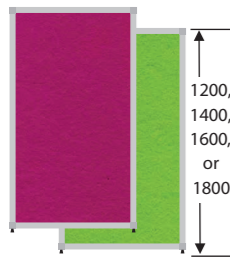

Hauteur Height Höhe	1200 mm	1400 mm	1600 mm	1800 mm
	Ref. ATT 1200 x 610 Ref. ATT 1200 x 810 Ref. ATT 1200 x 1010 Ref. ATT 1200 x 1210 Ref. ATT 1200 x 1410 Ref. ATT 1200 x 1610	Ref. ATT 1400 x 610 Ref. ATT 1400 x 810 Ref. ATT 1400 x 1010 Ref. ATT 1400 x 1210 Ref. ATT 1400 x 1410 Ref. ATT 1400 x 1610	Ref. ATT 1600 x 610 Ref. ATT 1600 x 810 Ref. ATT 1600 x 1010 Ref. ATT 1600 x 1210 Ref. ATT 1600 x 1410 Ref. ATT 1600 x 1610	Ref. ATT 1800 x 610 Ref. ATT 1800 x 810 Ref. ATT 1800 x 1010 Ref. ATT 1800 x 1210 Ref. ATT 1800 x 1410 Ref. ATT 1800 x 1610

Avec verre acrylique 3mm ou polycarbonate alvéolaire 6mm
With 3mm acrylic glass or 6mm alveolar polycarbonate
Mit 3mm Acrylglas oder 6mm Klarpolycarbonat

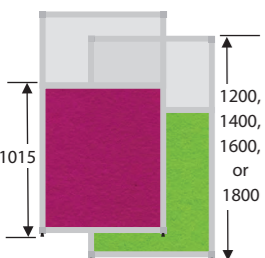

Ref. ATJ

Incolore
Colourless
Klar



Ref. ATG

Fumé gris
Gray tinted
Grau Rauch



Ref. ATL

Opale
Opal
Opal



Ref. ATP

Polycarbonate alvéolaire incolore
Classement feu M1 / B, s1, d0
Clear alveolar polycarbonate
Fire safety classification B, s1, d0
Klarpolycarbonat
Feuersicherung Class B, s1, d0



Ref. MVP 300

Pied sur platine plate
Prix unitaire
Foot on flat plate
Unit price
Fuß auf flacher Platte
Stückpreis

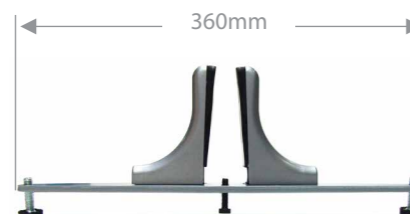

Ref. MVP 360

Pied Réglable
Prix unitaire
Adjustable foot
Unit price
Verstellbarer Fuß
Stückpreis

**ÉCRAN DE BUREAU
SUPER-ACOUSTIQUE**

**SUPER-ACOUSTIC
DESK SCREEN**

**SUPER AKUSTIK-
TISCH-TRENNWAND**

Hauteur Height Höhe	400 mm	600 mm	800 mm
	Ref. ATB 400 x 800 Ref. ATB 400 x 1000 Ref. ATB 400 x 1200 Ref. ATB 400 x 1400 Ref. ATB 400 x 1600 Ref. ATB 400 x 1800	Ref. ATB 600 x 800 Ref. ATB 600 x 1000 Ref. ATB 600 x 1200 Ref. ATB 600 x 1400 Ref. ATB 600 x 1600 Ref. ATB 600 x 1800	Ref. ATB 800 x 800 Ref. ATB 800 x 1000 Ref. ATB 800 x 1200 Ref. ATB 800 x 1400 Ref. ATB 800 x 1600 Ref. ATB 800 x 1800



Avec verre acrylique incolore, fumé gris ou opale de 3mm ou polycarbonate alvéolaire de 6mm, à préciser à la commande

With 3mm colourless, gray tinted or opal acrylic glass or 6mm alveolar polycarbonate, please specify when ordering

Mit 3mm Klar, grau Rauch oder Opal Acrylglas oder 6mm Klarpolycarbonat, bitte bei Bestellung angeben

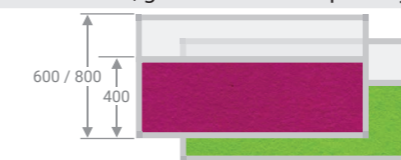

Ref. ATA 600 x 800 Ref. ATA 600 x 1000 Ref. ATA 600 x 1200 Ref. ATA 600 x 1400 Ref. ATA 600 x 1600 Ref. ATA 600 x 1800	Ref. ATA 800 x 800 Ref. ATA 800 x 1000 Ref. ATA 800 x 1200 Ref. ATA 800 x 1400 Ref. ATA 800 x 1600 Ref. ATA 800 x 1800
---	---

Prix unitaire	Unit price	Stückpreis
---------------	------------	------------

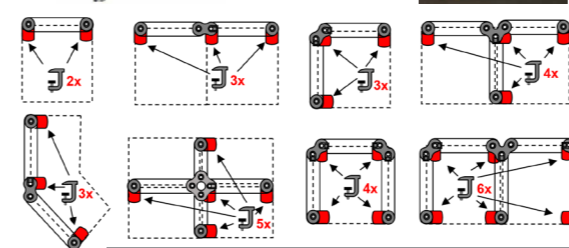

Position et quantité de pinces nécessaires selon l'implantation
Clamps position and number required depending on the layout
Klammern Positionen und Mengen erforderlich je nach Standort.



Ref. MVT 280
Ref. MVT 380



Ref. MVU 280
Ref. MVU 380

FIXATION POUR BUREAUX BENCH
Veillez préciser l'épaisseur du plateau
Please specify the thickness of the desk surface

FIXING FOR BENCH DESKS
Please specify the thickness of the desk surface

BEFESTIGUNG FÜR BENCH SCHREIBTISCHE
Bitte geben Sie die Stärke der Tischplatte an

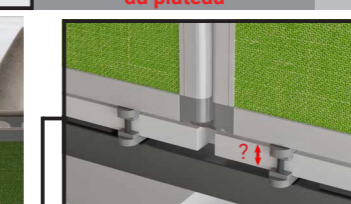

Ref. PBS

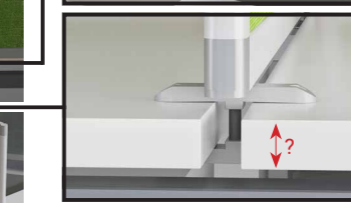

Ref. PBD

Sabot à poser sur le bureau

Base to place on the desk

Sockel auf den Tisch zu lege



Ref. MVZ 200

 VERRE ACRYLIQUE
+ POLYCARBONATE

 ACRYLIC GLASS +
POLYCARBONATE

 ACRYLGLAS +
POLYCARBONAT

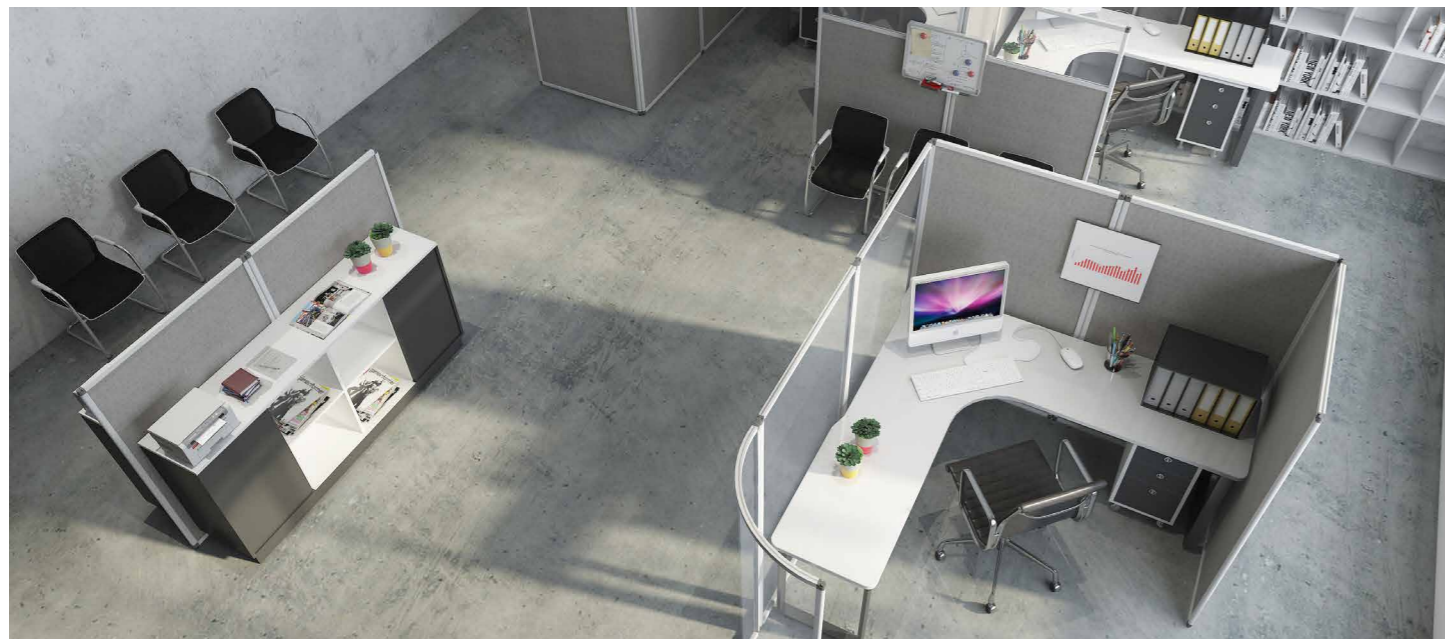

Store
pour cloisonnettes en verre acrylique

Venetian blind
for acrylic glass screens

Jalousie
für Acrylglas Stellwände

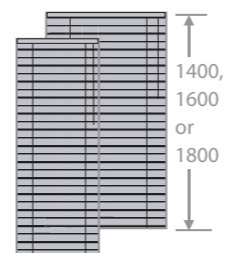

Hauteur
Height
Höhe **1400 mm**

- Ref. MVV 1400 x 610
- Ref. MVV 1400 x 810
- Ref. MVV 1400 x 1010
- Ref. MVV 1400 x 1210

1600 mm

- Ref. MVV 1600 x 610
- Ref. MVV 1600 x 810
- Ref. MVV 1600 x 1010
- Ref. MVV 1600 x 1210

1800 mm

- Ref. MVV 1800 x 610
- Ref. MVV 1800 x 810
- Ref. MVV 1800 x 1010
- Ref. MVV 1800 x 1210

**CLOISONNETTE
VERRE ACRYLIQUE
+ POLYCARBONATE**

**ACRYLIC GLASS +
POLYCARBONATE
SCREEN**

**ACRYLGLAS +
POLYCARBONAT
STELLWAND**

**ÉCRAN DE BUREAU
VERRE ACRYLIQUE
+ POLYCARBONATE**

**ACRYLIC GLASS +
POLYCARBONATE
DESK SCREEN**

**ACRYLGLAS +
POLYCARBONAT
TISCH-TRENNWAND**

Kit de montage livré avec chaque cloisonnette
Fitting set supplied with each screen
Ein Bausatz versorgt mit jeder Stellwand

Hauteur Height Höhe	1200 mm	1400 mm	1600 mm	1800 mm
	Ref. _____ 1200 x 610	Ref. _____ 1400 x 610	Ref. _____ 1600 x 610	Ref. _____ 1800 x 610
	Ref. _____ 1200 x 810	Ref. _____ 1400 x 810	Ref. _____ 1600 x 810	Ref. _____ 1800 x 810
	Ref. _____ 1200 x 1010	Ref. _____ 1400 x 1010	Ref. _____ 1600 x 1010	Ref. _____ 1800 x 1010
	Ref. _____ 1200 x 1210	Ref. _____ 1400 x 1210	Ref. _____ 1600 x 1210	Ref. _____ 1800 x 1210
	Ref. _____ 1200 x R610	Ref. _____ 1400 x R610	Ref. _____ 1600 x R610	Ref. _____ 1800 x R610
	Ref. _____ 1200 x R810	Ref. _____ 1400 x R810	Ref. _____ 1600 x R810	Ref. _____ 1800 x R810

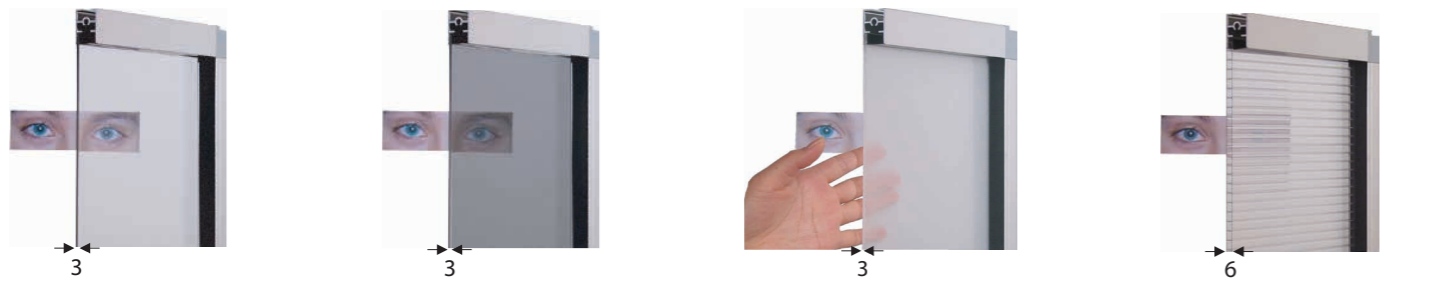

Ref. MAJ	Ref. MAG	Ref. MAL	Polycarbonate alvéolaire incolore Classement feu M1 / B, s1, d0
Incolore	Fumé gris	Opale	Clear alveolar polycarbonate Fire safety classification B, s1, d0
Colourless	Gray tinted	Opal	Klarpolycarbonat Feuersicherung Class B, s1, d0
Klar	Grau Rauch	Opal	

Avec polycarbonate alvéolaire 6mm
With 6mm alveolar polycarbonate
Mit 6mm Klarpolycarbonat

Ref. MAP 1200 x 610	Ref. MAP 1400 x 610	Ref. MAP 1600 x 610	Ref. MAP 1800 x 610
Ref. MAP 1200 x 810	Ref. MAP 1400 x 810	Ref. MAP 1600 x 810	Ref. MAP 1800 x 810
Ref. MAP 1200 x 1010	Ref. MAP 1400 x 1010	Ref. MAP 1600 x 1010	Ref. MAP 1800 x 1010
Ref. MAP 1200 x 1210	Ref. MAP 1400 x 1210	Ref. MAP 1600 x 1210	Ref. MAP 1800 x 1210
Ref. MAP 1200 x 1410	Ref. MAP 1400 x 1410	Ref. MAP 1600 x 1410	Ref. MAP 1800 x 1410
Ref. MAP 1200 x 1610	Ref. MAP 1400 x 1610	Ref. MAP 1600 x 1610	Ref. MAP 1800 x 1610
Ref. MAP 1200 x R810	Ref. MAP 1400 x R810	Ref. MAP 1600 x R810	



Ref. MVP 300
Pied sur platine plate
Prix unitaire
Foot on flat plate
Unit price
Fuß auf flacher Platte
Stückpreis

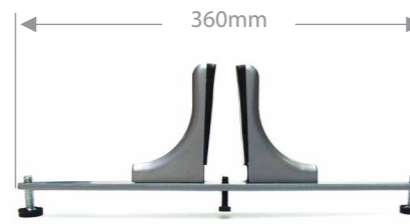

Ref. MVP 360
Pied Réglable
Prix unitaire
Adjustable foot
Unit price
Verstellbarer Fuß
Stückpreis

Avec verre acrylique incolore, fumé gris ou opale de 3mm ou polycarbonate alvéolaire de 6mm, à préciser à la commande
With 3mm colourless, gray tinted or opal acrylic glass or 6mm alveolar polycarbonate, please specify when ordering
Mit 3mm Klar, grau Rauch oder Opal Acrylglas oder 6mm Klarpolycarbonat, bitte bei Bestellung angeben

Hauteur Height Höhe	400 mm	600 mm	800 mm
	Ref. MVA 400 x 800	Ref. MVA 600 x 800	Ref. MVA 800 x 800
	Ref. MVA 400 x 1000	Ref. MVA 600 x 1000	Ref. MVA 800 x 1000
	Ref. MVA 400 x 1200	Ref. MVA 600 x 1200	Ref. MVA 800 x 1200
	Ref. MVA 400 x 1400	Ref. MVA 600 x 1400	Ref. MVA 800 x 1400
	Ref. MVA 400 x 1600	Ref. MVA 600 x 1600	Ref. MVA 800 x 1600
	Ref. MVA 400 x 1800	Ref. MVA 600 x 1800	Ref. MVA 800 x 1800

Prix unitaire	Unit price	Stückpreis
<p>Ref. MVT 280 → 10 – 28mm Ref. MVT 380 → 20 – 38mm</p>		<p>Ref. MVT 280 Ref. MVT 380</p>
		<p>Ref. MVU 280 Ref. MVU 380</p>
<p>Position et quantité de pinces nécessaires selon l'implantation Clamps position and number required depending on the layout Klammern Positionen und Mengen erforderlich je nach Standort.</p>	<p>FIXATION POUR BUREAUX BENCH Veuillez préciser l'épaisseur du plateau</p>	<p>FIXING FOR BENCH DESKS Please specify the thickness of the desk surface</p>
	<p>BEFESTIGUNG FÜR BENCH SCHREIBTISCHE Bitte geben Sie die Stärke der Tischplatte an</p>	

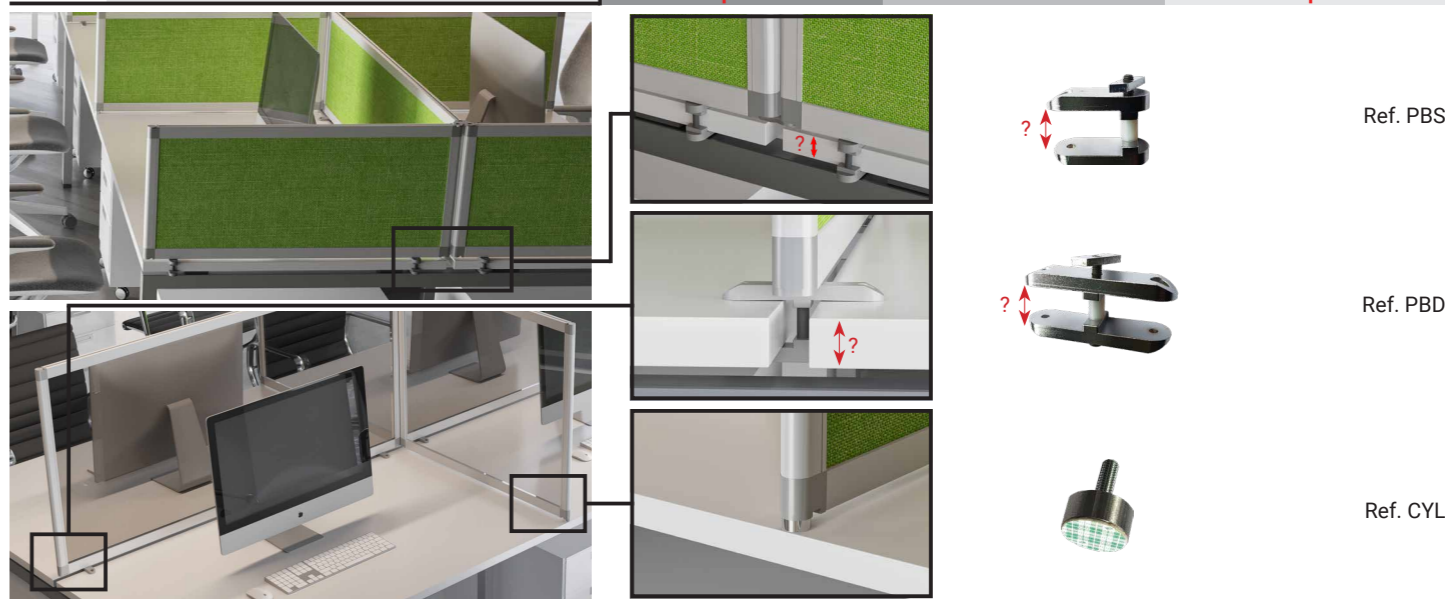

Sabot à poser sur le bureau Base to place on the desk Sockel auf den Tisch zu lege

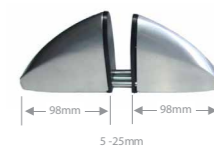

Ref. MVZ 200

PANNEAUX D’AFFICHAGE MAGNÉTIQUES

MAGNETIC NOTICE BOARDS

MAGNETISCHE ANSCHLAGTAFELN



Kit de montage livré avec chaque cloisonnette
Fitting set supplied with each screen
Ein Bausatz versorgt mit jeder Stellwand

ÉCRAN DE BUREAU MAGNÉTIQUE

MAGNETIC DESK SCREEN

MAGNETISCH TISCH-TRENNWAND

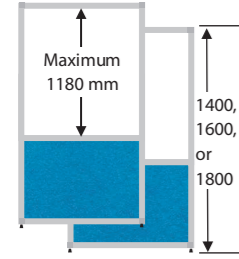
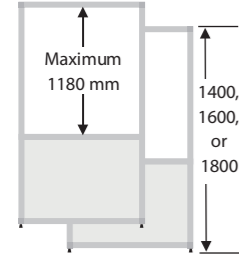
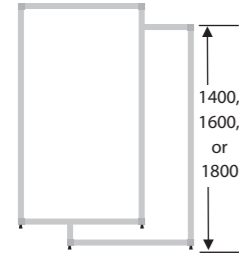
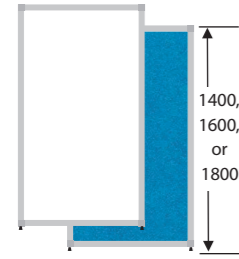
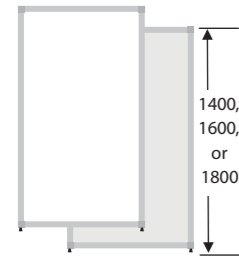

Hauteur Height Höhe	1400 mm	1600 mm	1800 mm
1 face magnétique émaillée + 1 face mélaminé blanc			
1 enamelled magnetic side + 1 side white melamine			
1 emailliert magnetisch Seite + 1 weiße melaminierte Seite			

Ref. TMM 1400 x 610
Ref. TMM 1400 x 810
Ref. TMM 1400 x 1010
Ref. TMM 1400 x 1210

Ref. TMM 1600 x 610
Ref. TMM 1600 x 810
Ref. TMM 1600 x 1010
Ref. TMM 1600 x 1210

Ref. TMM 1800 x 610
Ref. TMM 1800 x 810
Ref. TMM 1800 x 1010
Ref. TMM 1800 x 1210

1 face magnétique émaillée + 1 face tissu			
1 enamelled magnetic side + 1 side fabric			
1 emailliert magnetisch Seite + 1 Seite Stoff			

Ref. TTT 1400 x 610
Ref. TTT 1400 x 810
Ref. TTT 1400 x 1010
Ref. TTT 1400 x 1210

Ref. TTT 1600 x 610
Ref. TTT 1600 x 810
Ref. TTT 1600 x 1010
Ref. TTT 1600 x 1210

Ref. TTT 1800 x 610
Ref. TTT 1800 x 810
Ref. TTT 1800 x 1010
Ref. TTT 1800 x 1210

2 faces magnétiques émaillées			
2 enamelled magnetic sides			
2 emailliert magnetisch Seiten			

Ref. TEX 1400 x 610
Ref. TEX 1400 x 810
Ref. TEX 1400 x 1010
Ref. TEX 1400 x 1210

Ref. TEX 1600 x 610
Ref. TEX 1600 x 810
Ref. TEX 1600 x 1010
Ref. TEX 1600 x 1210

Ref. TEX 1800 x 610
Ref. TEX 1800 x 810
Ref. TEX 1800 x 1010
Ref. TEX 1800 x 1210

2 faces magnétiques émaillées + Mélaminé			
2 enamelled magnetic sides + Melamine			
2 emailliert magnetisch Seiten + Melamin			

Ref. TMX 1400 x 610
Ref. TMX 1400 x 810
Ref. TMX 1400 x 1010
Ref. TMX 1400 x 1210
Ref. TMX 1400 x 1410
Ref. TMX 1400 x 1610

Ref. TMX 1600 x 610
Ref. TMX 1600 x 810
Ref. TMX 1600 x 1010
Ref. TMX 1600 x 1210
Ref. TMX 1600 x 1410
Ref. TMX 1600 x 1610

Ref. TMX 1800 x 610
Ref. TMX 1800 x 810
Ref. TMX 1800 x 1010
Ref. TMX 1800 x 1210
Ref. TMX 1800 x 1410
Ref. TMX 1800 x 1610

2 faces magnétiques émaillées + Tissu			
2 enamelled magnetic sides + Fabric			
2 emailliert magnetisch Seiten + Stoff			

Ref. TTX 1400 x 610
Ref. TTX 1400 x 810
Ref. TTX 1400 x 1010
Ref. TTX 1400 x 1210
Ref. TTX 1400 x 1410
Ref. TTX 1400 x 1610

Ref. TTX 1600 x 610
Ref. TTX 1600 x 810
Ref. TTX 1600 x 1010
Ref. TTX 1600 x 1210
Ref. TTX 1600 x 1410
Ref. TTX 1600 x 1610

Ref. TTX 1800 x 610
Ref. TTX 1800 x 810
Ref. TTX 1800 x 1010
Ref. TTX 1800 x 1210
Ref. TTX 1800 x 1410
Ref. TTX 1800 x 1610

Hauteur Height Höhe	400 mm	600 mm	800 mm
---------------------------	--------	--------	--------

Ref. TPB 400 x 800
Ref. TPB 400 x 1000
Ref. TPB 400 x 1200
Ref. TPB 400 x 1400
Ref. TPB 400 x 1600
Ref. TPB 400 x 1800

Ref. TPB 600 x 800
Ref. TPB 600 x 1000
Ref. TPB 600 x 1200
Ref. TPB 600 x 1400
Ref. TPB 600 x 1600
Ref. TPB 600 x 1800

Ref. TPB 800 x 800
Ref. TPB 800 x 1000
Ref. TPB 800 x 1200
Ref. TPB 800 x 1400
Ref. TPB 800 x 1600
Ref. TPB 800 x 1800



Avec verre acrylique incolore, fumé gris ou opale de 3mm ou polycarbonate alvéolaire de 6mm, à préciser à la commande

With 3mm colourless, gray tinted or opal acrylic glass or 6mm alveolar polycarbonate, please specify when ordering

Mit 3mm Klar, grau Rauch oder Opal Acrylglas oder 6mm Klarpolycarbonat, bitte bei Bestellung angeben



Ref. TPA 600 x 800
Ref. TPA 600 x 1000
Ref. TPA 600 x 1200
Ref. TPA 600 x 1400
Ref. TPA 600 x 1600
Ref. TPA 600 x 1800

Ref. TPA 800 x 800
Ref. TPA 800 x 1000
Ref. TPA 800 x 1200
Ref. TPA 800 x 1400
Ref. TPA 800 x 1600
Ref. TPA 800 x 1800

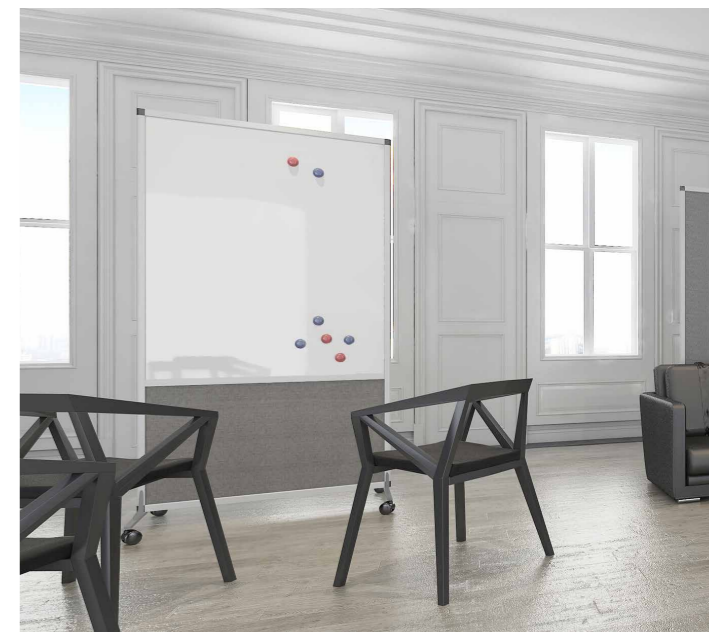
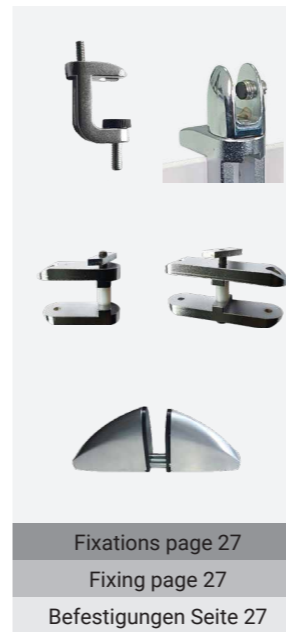

PIETEMENTS + ROULETTES

FEET + CASTORS

FÜßE + ROLLEN

Nombre de pieds suivant l'implantation :

Number of feet required depends on the layout:

Zahl der Füße kommt darauf das Layout an:

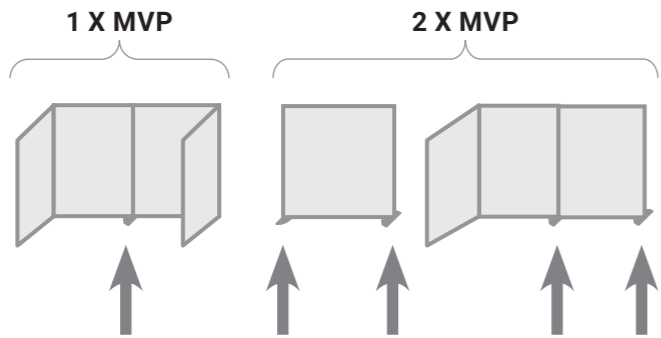

Pas de pied nécessaire pour ces implantations :

No feet required for these layouts:

Für diese Layouts sind keine Füße erforderlich:

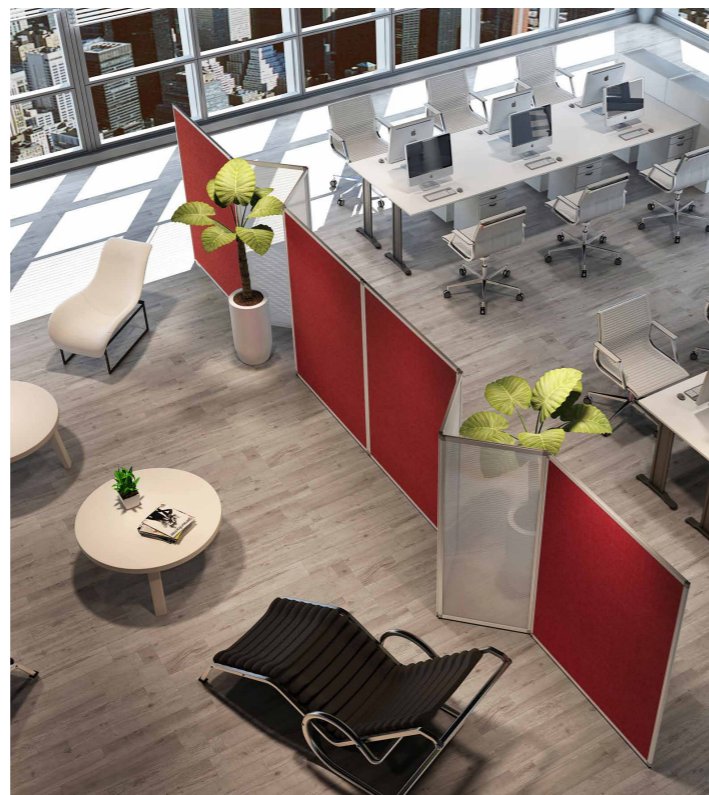
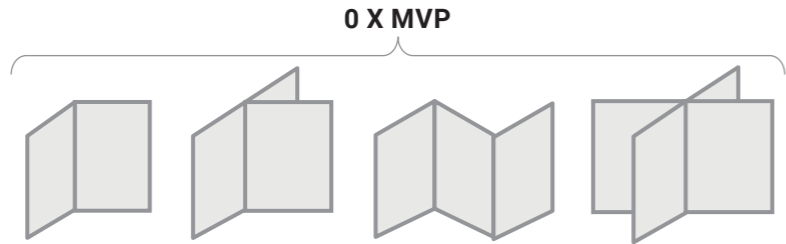

Pied sur platine plate
Prix unitaire

Foot on flat plate
Unit price

Fuß auf flacher Platte
Stückpreis

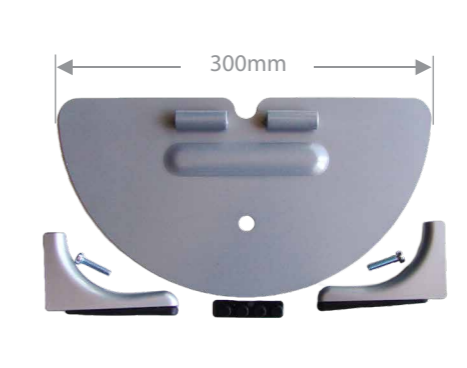

Ref. MVP 300

Pied réglable
Prix unitaire

Adjustable foot
Unit price

Verstellbarer Fuß
Stückpreis

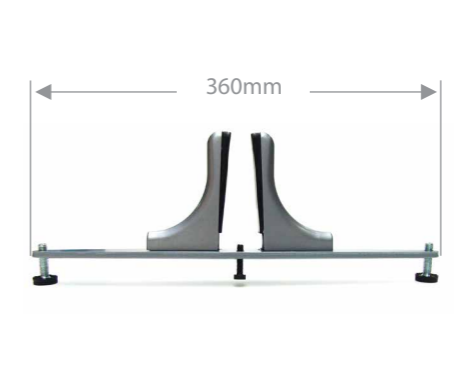

Ref. MVP 360

Kit complet 4 roulettes avec freins
+ 2 barres
(pour hauteur maxi 1800mm)

4 locking castor full set + 2 bars
(for maximum height 1800mm)

Komplettsatz mit 4 Rollen mit Bremsfunktion
(für maxi Höhe 1800mm)



Ref. MVX 380

 **TOLE PERFORÉE
MAGNÉTIQUE**

 **MAGNETIC
PERFORATED
METAL SHEET**

 **MAGNETISCH
LOCHBLECH**

 **PANNEAUX POUR
BANQUE D'ACCUEIL**

 **PANELS FOR
RECEPTION DESK**

 **WÄNDE FÜR
EMPFANGSTHEKE**



Kit de montage livré avec chaque cloisonnette

Fitting set supplied with each screen

Ein Bausatz versorgt mit jeder Stellwand

Hauteur Height Höhe	1200 mm	1400 mm	1600 mm	1800 mm
---------------------------	---------	---------	---------	---------

Tôle perforée magnétique acier laqué RAL 9006
RAL 9006 lacquered magnetic perforated metal sheet
Lackierten magnetisch Lochblech RAL 9006

Ref. MPP 1200 x 610 Ref. MPP 1200 x 810 Ref. MPP 1200 x 1010	Ref. MPP 1400 x 610 Ref. MPP 1400 x 810 Ref. MPP 1400 x 1010	Ref. MPP 1600 x 610 Ref. MPP 1600 x 810 Ref. MPP 1600 x 1010	Ref. MPP 1800 x 610 Ref. MPP 1800 x 810 Ref. MPP 1800 x 1010
--	--	--	--

Tôle perforée magnétique acier laqué RAL 9006 + Mélaminé
RAL 9006 lacquered magnetic perforated metal sheet + Melamine
Lackierten magnetisch Lochblech RAL 9006 + Melamin

Ref. MPM 1400 x 610 Ref. MPM 1400 x 810 Ref. MPM 1400 x 1010 Ref. MPM 1400 x 1210 Ref. MPM 1400 x 1410 Ref. MPM 1400 x 1610	Ref. MPM 1600 x 610 Ref. MPM 1600 x 810 Ref. MPM 1600 x 1010 Ref. MPM 1600 x 1210 Ref. MPM 1600 x 1410 Ref. MPM 1600 x 1610	Ref. MPM 1800 x 610 Ref. MPM 1800 x 810 Ref. MPM 1800 x 1010 Ref. MPM 1800 x 1210 Ref. MPM 1800 x 1410 Ref. MPM 1800 x 1610
--	--	--

Tôle perforée magnétique acier laqué RAL 9006 + Tissu
RAL 9006 lacquered magnetic perforated metal sheet + Fabric
Lackierten magnetisch Lochblech RAL 9006 + Stoff

Ref. MPT 1400 x 610 Ref. MPT 1400 x 810 Ref. MPT 1400 x 1010 Ref. MPT 1400 x 1210 Ref. MPT 1400 x 1410 Ref. MPT 1400 x 1610	Ref. MPT 1600 x 610 Ref. MPT 1600 x 810 Ref. MPT 1600 x 1010 Ref. MPT 1600 x 1210 Ref. MPT 1600 x 1410 Ref. MPT 1600 x 1610	Ref. MPT 1800 x 610 Ref. MPT 1800 x 810 Ref. MPT 1800 x 1010 Ref. MPT 1800 x 1210 Ref. MPT 1800 x 1410 Ref. MPT 1800 x 1610
--	--	--

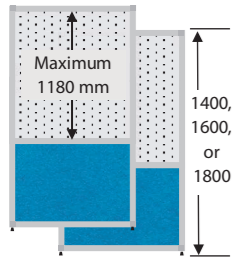
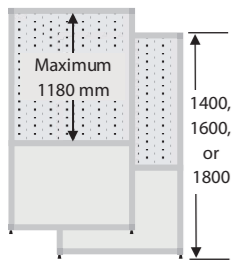
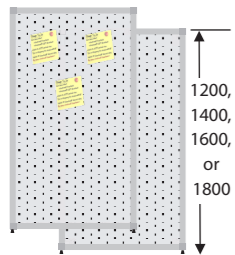

Mélaminé 19mm
19mm melamine
19mm Melamin

Hauteur
Height
Höhe

1030 mm

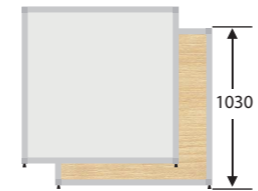

Ref. MMM 1030 x 800
Ref. MMM 1030 x 825
Ref. MMM 1030 x 1000
Ref. MMM 1030 x 1200
Ref. MMM 1030 x 1400
Ref. MMM 1030 x 1600

Tissu
Fabric
Stoff

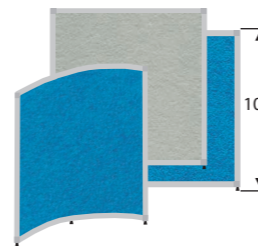

Ref. MTT 1030 x 800
Ref. MTT 1030 x 825
Ref. MTT 1030 x 1000
Ref. MTT 1030 x 1200
Ref. MTT 1030 x 1400
Ref. MTT 1030 x 1600
Ref. MTT 1030 x R800

Tôle perforée acier laqué RAL 9006
RAL 9006 lacquered perforated metal sheet
Lackierten Lochblech RAL 9006

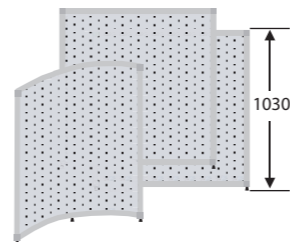

Ref. MPP 1030 x 800
Ref. MPP 1030 x 825
Ref. MPP 1030 x 1000
Ref. MPP 1030 x 1200
Ref. MPP 1030 x 1400
Ref. MPP 1030 x 1600
Ref. MPP 1030 x R800

Tablette en verre Securit dépoli 8mm avec supports MCT 230
8mm frosted Securit glass slab with holders MCT 230
Glasplatte, 8mm Securit Mattglas mit Stützer MCT 230

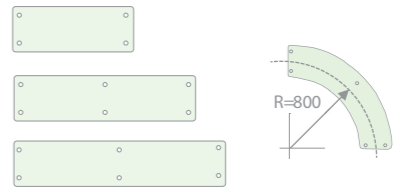

Ref. MCW 300 x 800
Ref. MCW 300 x 1000
Ref. MCW 300 x 1200
Ref. MCW 300 x 1400
Ref. MCW 300 x 1600
Ref. MCW 300 x R800

Support pour tablette bois ou verre
Holder for glass or wooden slab
Stütze für Holz oder Glasplatte



Ref. MCT 230





POSTES DE TRAVAIL



WORKSTATIONS



ARBEITSPLÄTZE

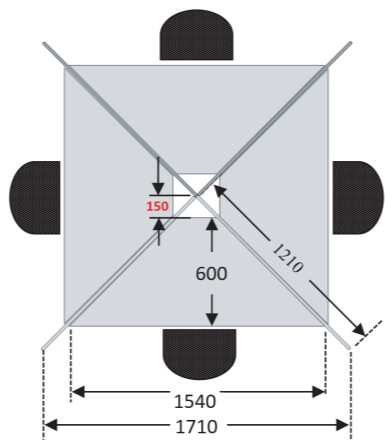
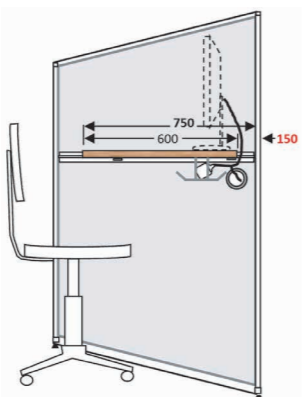
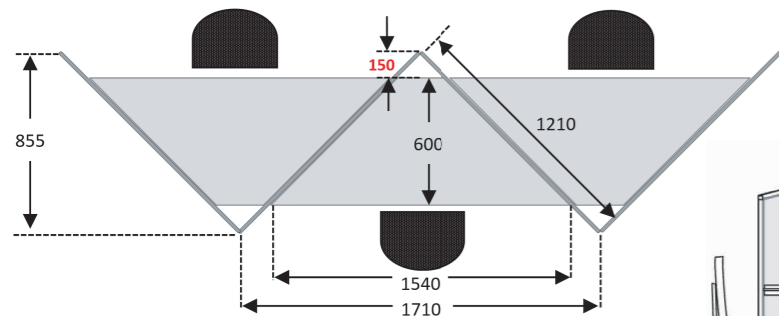
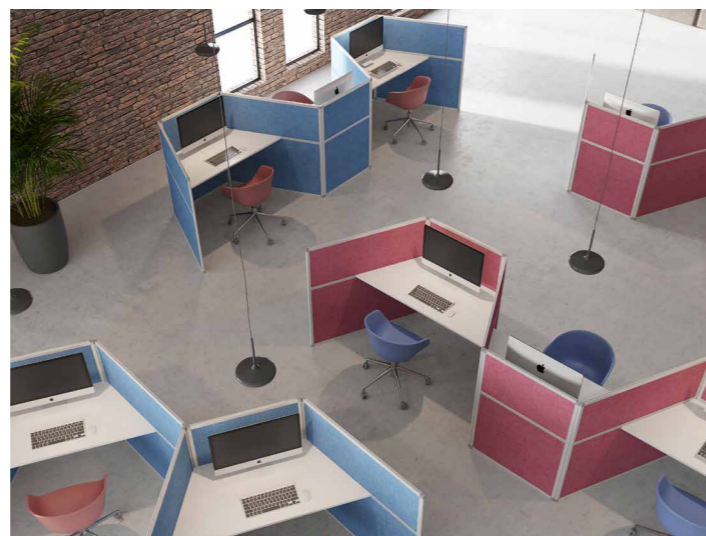

Rail aluminium pour fixation plateau ou accessoires (voir page 40).
A intégrer dans la cloison.

Aluminum profile for desk surfaces or accessories (see page 40).
To be integrated into the screen.

Alu-Profil für Tischplatten-Befestigung oder Zubehör (siehe Seite 40).
In die Wand einzulassen.

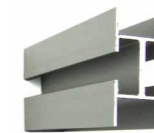
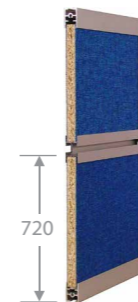

- Ref. MVH 100/ 610
- Ref. MVH 100/ 810
- Ref. MVH 100/ 1010
- Ref. MVH 100/ 1210
- Ref. MVH 100/ 1410
- Ref. MVH 100/ 1610
- Ref. MVH 100/ 1810

4 Supports pour plateau

4 Holders for desk surfaces

4 Halter für Tischplatte



Ref. MVH 110

Plateau mélaminé blanc ou gris
28mm + 4 supports MVH 110

28mm thick white or grey
desk surface + 4 holders MVH 110

28mm Melamin Tischplatte weiss
oder grau + 4 Halterungen MVH 110



Ref. MVH 600 x TRAP

Prise compact type E
avec chargeur USB 5V / 2,4A

E type compact desk power plug
with 5V / 2,4A USB charger

Kompakte Typ E Schreibtischsteckdose
mit USB-Ladefunktion 5V / 2,4A



Ref. MVH 213

Goulotte pour câbles longueur
420mm à fixer sous le plateau

Cable support 420mm long to fix
under the desk surface

Kabelwanne 420mm lang under
Tischplatte zu befestigen

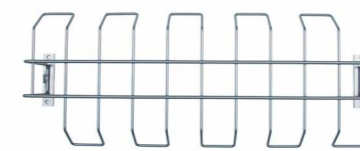

Ref. MVH 212

Passage pour câbles
(à prévoir à la commande)

Cable pathway
(to be specified when ordered)

Kabeldurchführung
(Bei Bestellung angeben)

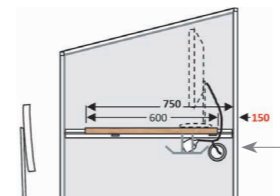

Ref. MVF 111

 **POSTES DE TRAVAIL
+ CALL CENTER**

 **WORKSTATIONS
+ CALL CENTER**

 **ARBEITSPLÄTZE
+ CALL CENTER**

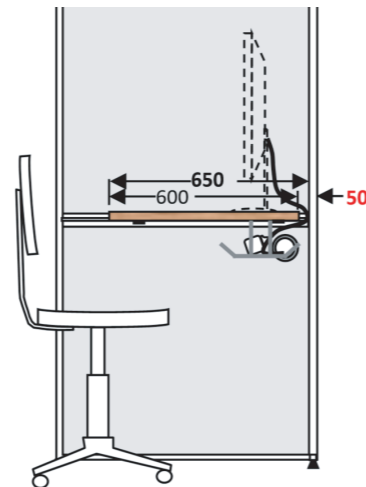
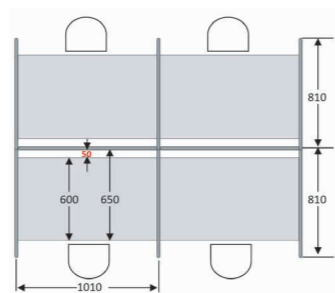
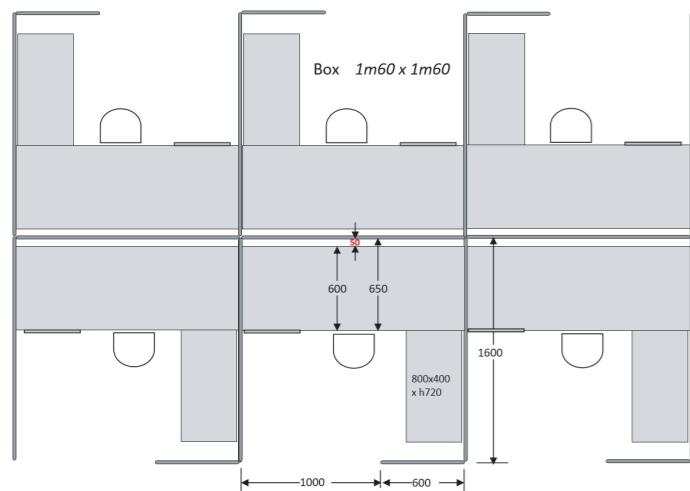

Rail aluminium pour fixation plateau ou accessoires (voir page 40).
A intégrer dans la cloison.

Aluminum profile for desk surfaces or accessories (see page 40).
To be integrated into the screen.

Alu-Profil für Tischplatten-Befestigung oder Zubehör (siehe Seite 40).
In die Wand einzulassen.

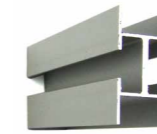
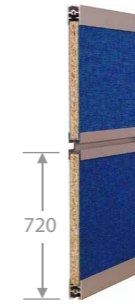

- Ref. MVH 100/ 610
- Ref. MVH 100/ 810
- Ref. MVH 100/ 1010
- Ref. MVH 100/ 1210
- Ref. MVH 100/ 1410
- Ref. MVH 100/ 1610
- Ref. MVH 100/ 1810

4 Supports pour plateau

4 Holders for desk surfaces

4 Halter für Tischplatte



Ref. MVH 110

Plateau mélaminé blanc ou gris
28mm + 4 supports MVH 110

28mm thick white or grey
desk surface + 4 holders MVH 110

28mm Melamin Tischplatte weiss
oder grau + 4 Halterungen MVH 110

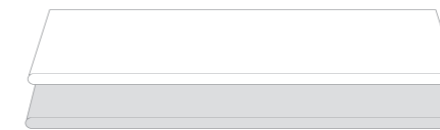

- Ref. MVH 600 x 800
- Ref. MVH 600 x 1000
- Ref. MVH 600 x 1200
- Ref. MVH 600 x 1400
- Ref. MVH 600 x 1600

Prise compact type E
avec chargeur USB 5V / 2,4A

E type compact desk power plug
with 5V / 2,4A USB charger

Kompakte Typ E Schreibtischsteckdose
mit USB-Ladefunktion 5V / 2,4A



Ref. MVH 213

Goulotte pour câbles longueur
420mm à fixer sous le plateau

Cable support 420mm long to fix
under the desk surface

Kabelwanne 420mm lang under
Tischplatte zu befestigen

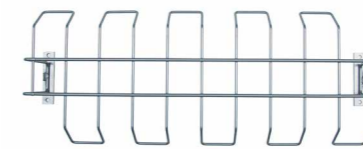

Ref. MVH 212

Passage pour câbles
(à prévoir à la commande)

Cable pathway
(to be specified when ordered)

Kabeldurchführung
(Bei Bestellung angeben)

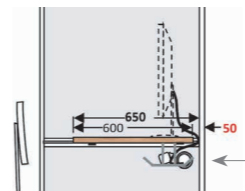

Ref. MVF 111



**REHAUSSE +
ÉCRAN EN VERRE**



**GLASS DESK
SCREEN + TOPPER**



**GLAS-
WÄNDE + AUFSATZ**



Rehausse en verre
trempé dépoli 5mm
5mm frosted tempered glass
(securit)
Aufsatz aus gehärtetem Mattglas
5mm stark (securit)

Ref. MGD 250/ 790
Ref. MGD 250/ 990
Ref. MGD 250/ 1190
Ref. MGD 250/ 1390
Ref. MGD 250/ 1590
Ref. MGD 250/ 1790

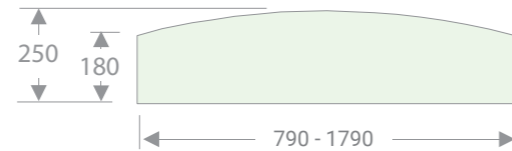

Clip pour verre
de 4 à 10mm avec écrou
Clip for 4 to 10mm glass
with nut
Klip für 4 bis 10mm starkes Glas
mit Mutter

Ref. MVU 002

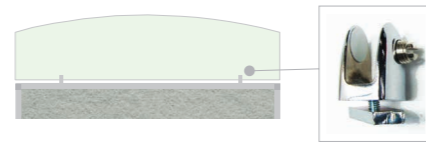

Ecrans en verre
trempé dépoli 5mm
Glass desk screens
5mm frosted tempered glass
Glaswände
aus gehärtetem Mattglas 5mm stark

Ref. MGD 450/ 790
Ref. MGD 450/ 990
Ref. MGD 450/ 1190
Ref. MGD 450/ 1390
Ref. MGD 450/ 1590
Ref. MGD 450/ 1790

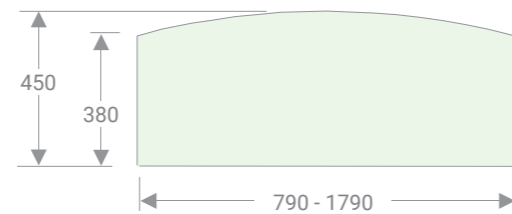

Pince bureau métallique
+ clip pour verre de 4 à 10mm
Metal desk clamp
+ clip for 4 to 10mm glass
Tischklammer
+ Klip für Glas von 4 bis 10mm

Ref. MVM 280
Ref. MVM 380

Ref. MVM 280 → 10 - 28mm
Ref. MVM 380 → 20 - 38mm

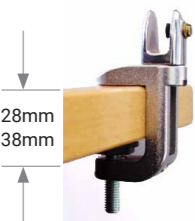



ACCESSOIRES



ACCESSORIES



ZUBEHÖR

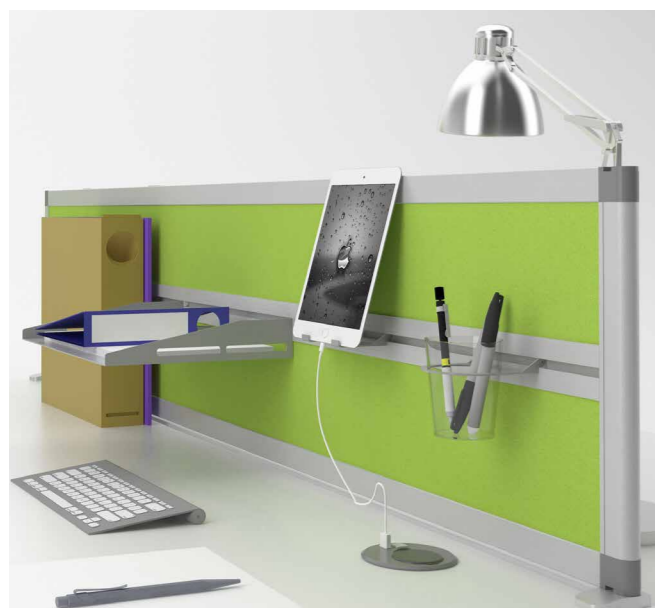

Rail aluminium pour accessoires sur les 2 faces de la cloison.
A prévoir à la fabrication.

Aluminium profile for accessories on both sides of the screen.
Must be specified prior to manufacture.

Alu-Profil für Zubehör an beiden Seiten der Trennwand.
Bei der Herstellung einzuplanen.

Ref. MVH 100/ 610
Ref. MVH 100/ 810
Ref. MVH 100/ 1010
Ref. MVH 100/ 1210
Ref. MVH 100/ 1410
Ref. MVH 100/ 1610
Ref. MVH 100/ 1810

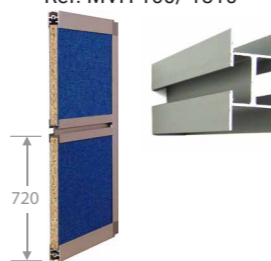

Plaque pour fixation accessoires 350 x H 330mm
A enclencher sur le profilé haut de la cloison.

Accessory plate 350 x H 330mm, interlocks on to the aluminum profile of the screen.

Ref. MVH 200



Platte zur Befestigung von Zubehör 350 x H 330mm, zum einrasten am oberen Profil der Trennwand.

Bac à Courrier 335 x 250 x 50mm

Ref. MVH 201

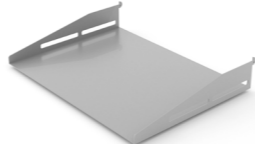

Paper tray 335 x 250 x 50mm

Ablagefach 335 x 250 x 50mm

Pot à crayon

Ref. MVH 204



Pen holder

Stift-Cup

Support tablette ou téléphone 80 x 60mm

Ref. MVH 206



Tablet or cell phone holder 80 x 60mm

Tablet- / Mobiltelefon-Halterung 80 x 60mm

Support inclinable et orientable pour écran LCD de 10 à 23"
Peut être fixé directement sur la cloison avec vis traversantes ou sur la plaque Ref. MVH 200.

Ref. MVH 209



10-23" LCD monitor mount full rotation
Can be fixed directly on the screen with screws through the panel or on the plate Ref. MVH 200.

Neig- und schwenkbare Halterung für 10-23 LCD-Monitor
Kann direkt an der Wand mit durchgehenden Schrauben oder an der Platte Ref. MVH 200 befestigt werden.

Crochet métallique



Metal hook



Metalhaken

Ref. MVD 200

Crochet porte manteau



Coat rack hook

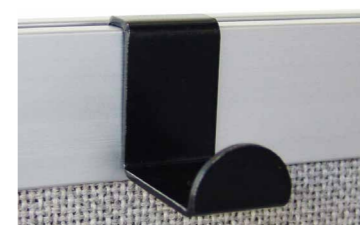

Kleiderhaken

Ref. MVC 111

Profilé d'obturation en PVC souple gris

Shutterprofile flexible grey PVC

Verstopfprofile aus grau Weich-PVC



Ref. MVX 001

Sabot à poser sur le bureau
Prix unitaire

Base to place on the desk
Unit price

Sockel auf den Tisch zu lege
Stückpreis

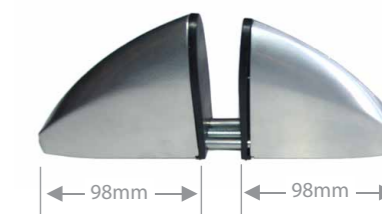

Ref. MVZ 200



**SOLUTIONS
ACOUSTIQUES**



**ACOUSTIC
SOLUTIONS**



**AKUSTISCHE
LÖSUNGEN**

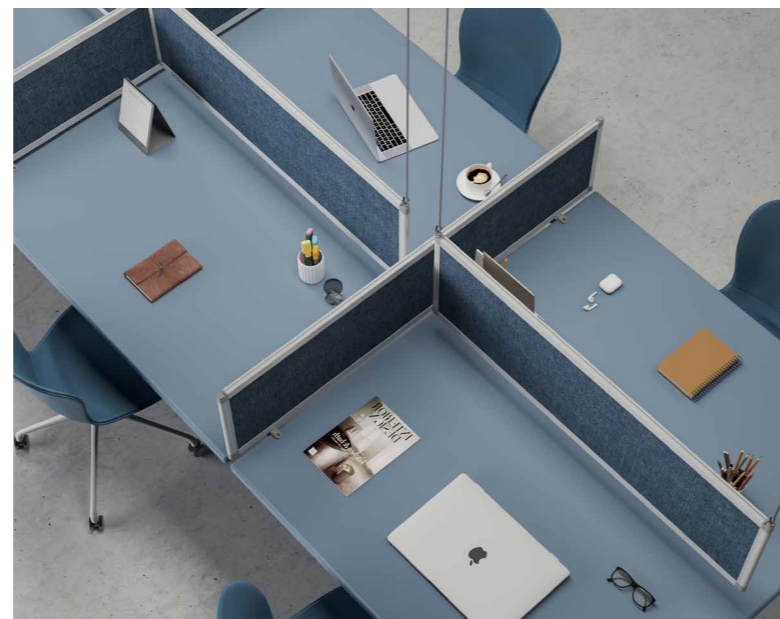

Panneaux suspendus et muraux
Super-Acoustique
Tests acoustiques page 17

Hanging and wall panels
Super-Acoustic
Acoustic tests page 17

Hänge- und wandpaneele
Super-Akustik
Akustikteste Seite 17

Hauteur Height Höhe	1000 mm	1200 mm	1400 mm	1600 mm
	Ref. ATT 1000 x 600 Ref. ATT 1000 x 800 Ref. ATT 1000 x 1000 Ref. ATT 1000 x 1200 Ref. ATT 1000 x 1400 Ref. ATT 1000 x 1600	Ref. ATT 1200 x 600 Ref. ATT 1200 x 800 Ref. ATT 1200 x 1000 Ref. ATT 1200 x 1200 Ref. ATT 1200 x 1400 Ref. ATT 1200 x 1600	Ref. ATT 1400 x 600 Ref. ATT 1400 x 800 Ref. ATT 1400 x 1000 Ref. ATT 1400 x 1200 Ref. ATT 1400 x 1400 Ref. ATT 1400 x 1600	Ref. ATT 1600 x 600 Ref. ATT 1600 x 800 Ref. ATT 1600 x 1000 Ref. ATT 1600 x 1200 Ref. ATT 1600 x 1400

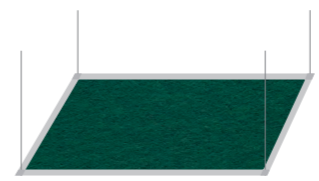

Fixation pour panneaux suspendus
cables longueur réglable
(maximum 2 m) vendus par deux

Fixing for hanging panels
Adjustable length cables
(maximum 2 m) sold by two

Befestigung für Hängepaneele
Kabel mit einstellbarer Länge
(maximal 2 m) zu zweit verkauft



Vertical
1 x APD



Horizontal
2 x APD



Ref. APD

Fixation pour panneaux muraux

Fixing for wall panels

Befestigung für Wandpaneele

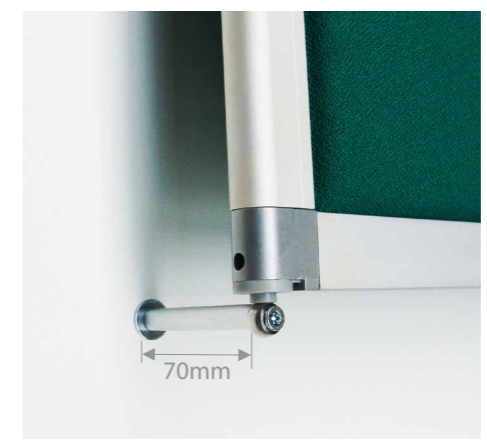

Ref. APM

 **CLOISONS MOBILES
À ANGLE DROIT**

 **FREESTANDING
ANGLE PARTITIONS**

 **BEWEGLICHE
ECKTRENNWÄNDE**

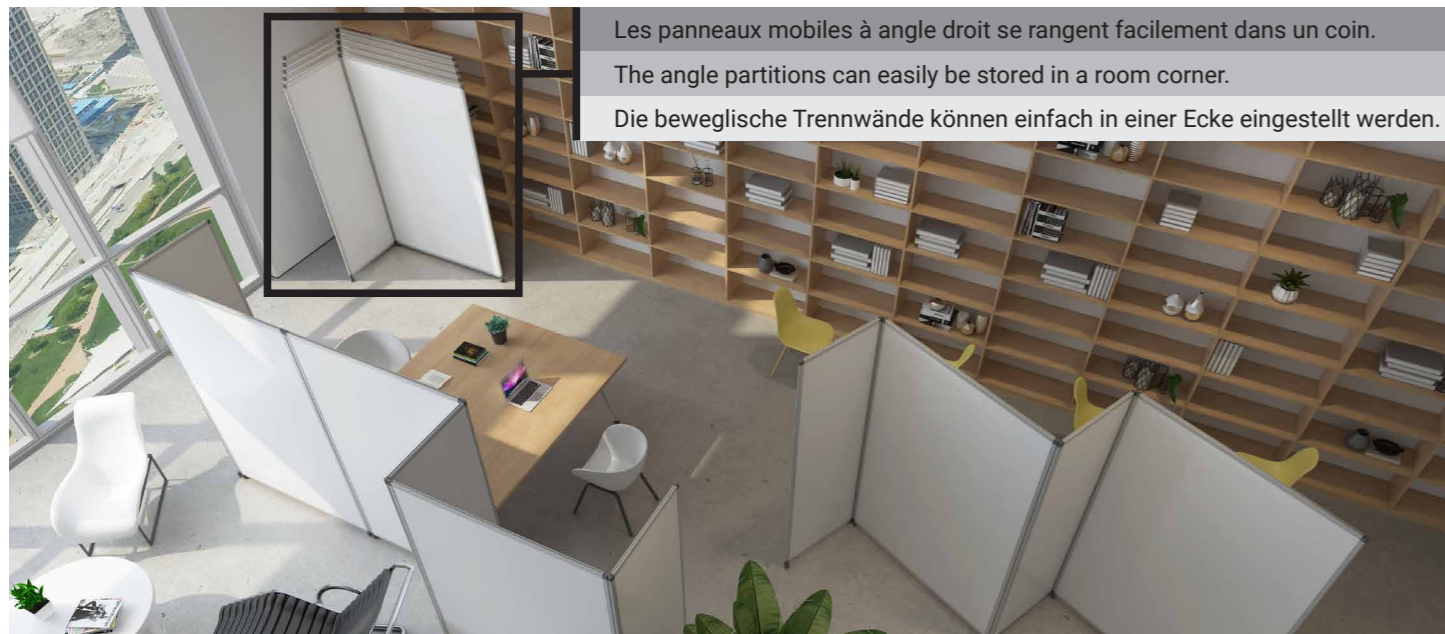
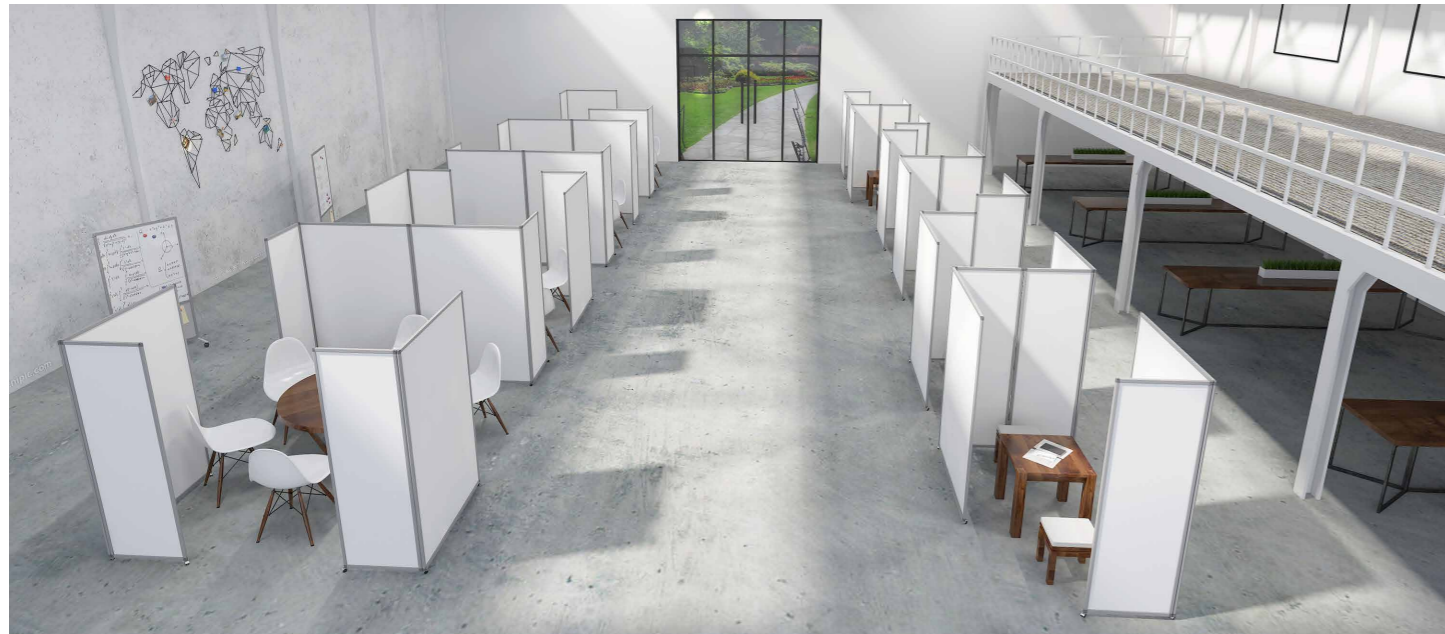

Les panneaux mobiles à angle droit se rangent facilement dans un coin.
The angle partitions can easily be stored in a room corner.
Die bewegliche Trennwände können einfach in einer Ecke eingestellt werden.

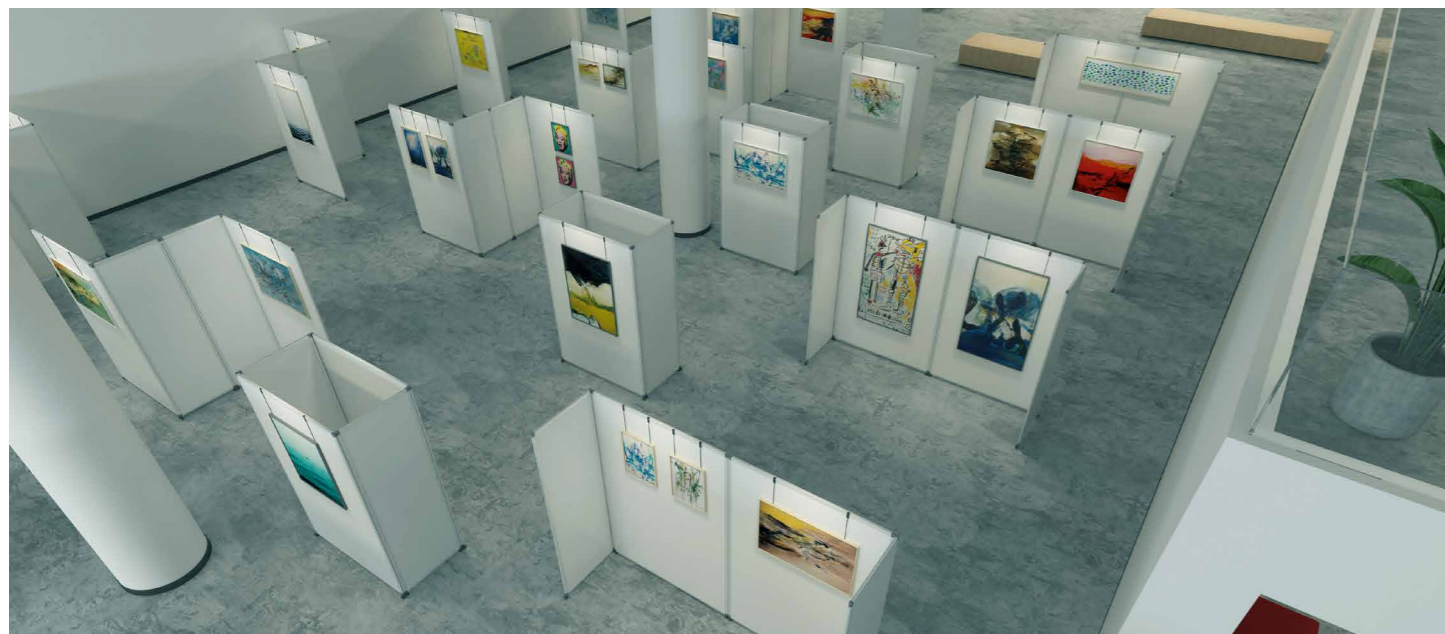

Les Cloisons Reyem à angle droit sur 3 roulettes permettent de séparer rapidement vos espaces, peuvent être utilisées dans des salles polyvalentes, musées, expositions...

The three-castor free-standing partitions by Reyem are a fast and easy solution to separate your spaces. They can be used in function rooms, museums, exhibitions and many other locations...

Die rechtwinkligen Reyem Trennwände auf 3 Rollen ermöglichen Ihnen eine schnelle Raumteilung und können in Mehrzweckhallen, Museen, Ausstellungsräumen usw. eingesetzt werden.

- ✓ BONNE STABILITE
- ✓ FACILE A DEPLACER ET A ASSEMBLER
- ✓ GAIN DE PLACE LORS DU RANGEMENT

- ✓ A STABLE SOLUTION
- ✓ EASY TO TRANSPORT AND ASSEMBLE
- ✓ SAVE VALUABLE STORAGE SPACE

- ✓ GUTE STABILITÄT
- ✓ EINFACH BEWEGBAR & ZUSAMMENBAUAR
- ✓ PLATZSPAREND VERSTAUBAR

Ensemble de deux cloisons + kit 3 roulettes
Mélaminé blanc de 8 mm

Pour d'autres coloris ou PVC blanc de 8 mm classé feu M1 / B, s3, d0 veuillez nous consulter.

Two partitions + 3 castor kit
8mm white melamine

For other colours, or 8mm white PVC with fire safety classification B, s3, d0, please contact us.

Einheit aus zwei Trennwänden + 3 Rollen satz
8 mm weiß Melamin

Für andere Farbe, oder 8 mm Weiß PVC, Feuersicherung Class B, s3, d0, kontaktieren Sie uns.

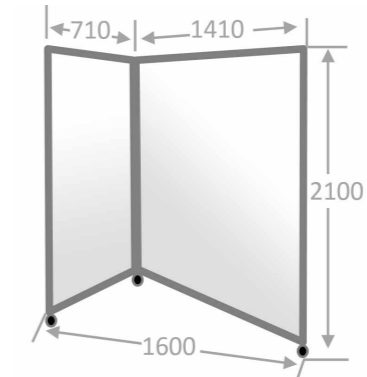

Ref. PAS 2100 1410 / 710



Roulettes avec frein
Locking castors
Rollen mit Bremsfunktion

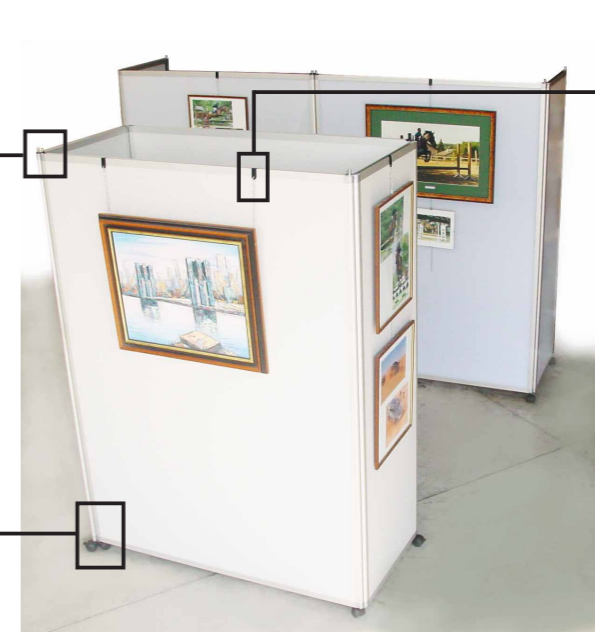

Crochet métallique
Metal hook
Metallhaken
Ref. MVD 200



Kit 3 roulettes uniquement
3 castor kit only
Einzel 3 Rollensatz
Ref. EP 57



CONDITIONS DE TRANSPORT

Frais de port et d'emballage pour la ZONE A :

Pour une commande prix tarif :
de 0 à 1 500 € = **100 €**
de 1 501 à 3 000 € = **50 €**
supérieur à 3 001 € = **FRANCO**

Frais de port et d'emballage pour la ZONE B :

Pour une commande prix tarif :
de 0 à 1 500 € = **120 €**
de 1 501 à 3 000 € = **60 €**
supérieur à 3 001 € = **FRANCO**

Frais de port et d'emballage pour les AUTRES DESTINATIONS, veuillez nous consulter.



CONDITIONS OF TRANSPORT

Shipping and packing costs for ZONE A:

For an order:
between €0 and €1500 price list = **€100**
between €1501 and €3000 price list = **€50**
over €3001 price list = **FREE DELIVERY**

Shipping and packing costs for ZONE B:

For an order:
between €0 and €1500 price list = **€120**
between €1501 and €3000 price list = **€60**
over €3001 price list = **FREE DELIVERY**

Shipping and packing costs for OTHER DESTINATIONS, please contact us.



BEFÖRDERUNGS-BEDINGUNGEN

Porto- und Verpackungskosten für die ZONE A:

Für eine Bestellung:
von 0 bis 1 500 € Listenpreis = **100 €**
von 1 501 bis 3 000 € Listenpreis = **50 €**
ab 3 001 € Listenpreis = **PORTOFREI**

Porto- und Verpackungskosten für die ZONE B:

Für eine Bestellung:
von 0 bis 1 500 € Listenpreis = **120 €**
von 1 501 bis 3 000 € Listenpreis = **60 €**
ab 3 001 € Listenpreis = **PORTOFREI**

Porto- und Verpackungskosten für ANDERE LANDER, bitte kontaktieren Sie uns.

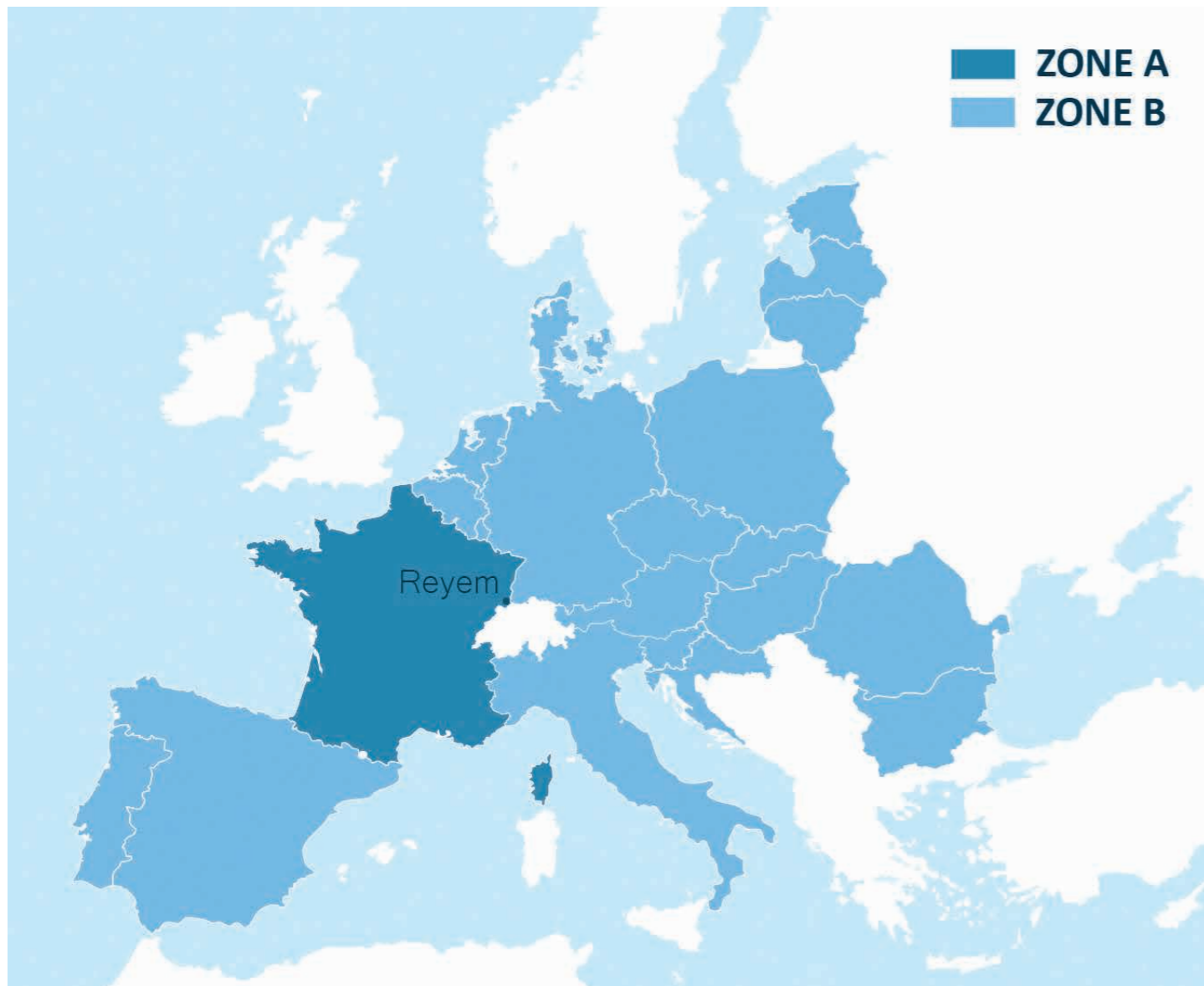



Reyem S.A.S.

ZA DE LA SAVONNERIE
FR-68460 LUTTERBACH
FRANCE

TEL : +33 (0)3 89 57 20 11



Reyem DEUTSCHLAND

LEBACHER STR. 4
DE-66121 SAARBRÜCKEN

POSTFACH 10 05 43
DE-66005 SAARBRÜCKEN

TEL: +49 (0)68 1/99 63 375

www.reyem.com

reyem@reyem.com